

Contents

1. Part Names
2. Basic Operation
3. Menu Operation
4. USB Media
5. AQUOS LINK and Other Devices
6. Operating the Monitor Using a PC (IP control)
7. Troubleshooting
8. Specifications, etc.

You can select an OSD language from among 7 languages.

English >>

Deutsch >>

Français >>

Italiano >>

Español >>

Русский >>

Polski >>

Ver. 1.15



SHARP®

AQUOS

LCD MONITOR

OPERATION MANUAL

- Please choose your favorite page from the content.
If you want to close the operation manual, press the **EXIT** button.
Also, if you want to return to the previously displayed page, press the **RETURN** button.

 DOLBY AUDIO™

 **HDMI**
HIGH-DEFINITION MULTIMEDIA INTERFACE

 **eilex**
PRISM

 **VIR**
FILTER

Contents

1. Part Names
2. Basic Operation
3. Menu Operation
4. USB Media
5. AQUOS LINK and Other Devices
6. Operating the Monitor Using a PC (IP control)
7. Troubleshooting
8. Specifications, etc.

You can select an OSD language from among 7 languages.

English >>

Deutsch >>

Français >>

Italiano >>

Español >>

Русский >>

Polski >>

Ver. 1.15



Contents

1. Part Names
 - 1-1. Monitor
 - 1-7. Name of Remote Control Buttons
2. Basic Operation
 - 2-1. Initial Installation
 - 2-3. Basic Operation
 - 2-4. Using Timer
 - 2-6. Listening with Headphones
3. Menu Operation
 - 3-1. How to Use Menu
 - 3-2. How to Use Setup Menu
 - 3-3. List of Setup Menu Items
 - 3-44. How to Use Application Menu
 - 3-45. Entering Letters (Software Keyboard)
4. USB Media
 - 4-1. Before Using USB Media
 - 4-7. Enjoying Photo
 - 4-22. Enjoying Music
 - 4-25. Enjoying Video
5. AQUOS LINK and Other Devices
 - 5-1. Connecting 8K output compatible Device
 - 5-5. Connecting 4K output compatible Device
 - 5-7. Viewing HDR Video (INPUT1, INPUT7)
 - 5-9. Using the AQUOS LINK
 - 5-15. Connecting Recorder, Player, etc.
 - 5-25. Connecting Recorder, Player or Game Player
 - 5-26. Connecting Audio Device
 - 5-27. Connecting PC
6. Operating the Monitor Using a PC (IP control)
 - 6-1. Connecting the Monitor and PC
 - 6-3. Settings to operate the Monitor
 - 6-4. Command list
7. Troubleshooting
 - 7-1. If You Suspect a Problem
 - 7-9. If Error Message Appears
 - 7-11. What If
8. Specifications, etc.
 - 8-1. specifications
 - 8-2. PC Supported signal timing
 - 8-3. AV Supported signal timing
 - 8-4. PC/AV HDMI input terminal pin configuration
 - 8-5. PC/AV D-sub input terminal pin configuration
 - 8-6. Dimensional Drawing
 - 8-7. Setting the Monitor on the Wall
 - 8-8. Software License

Contents

1. Part Names
2. Basic Operation
3. Menu Operation
4. USB Media
5. AQUOS LINK and Other Devices
6. Operating the Monitor Using a PC (IP control)
7. Troubleshooting
8. Specifications, etc.

You can select an OSD language from among 7 languages.

English >>

Deutsch >>

Français >>

Italiano >>

Español >>

Русский >>

Polski >>

Ver. 1.15



IMPORTANT INFORMATION



Information on the Disposal of this Equipment and its Batteries

IF YOU WISH TO DISPOSE OF THIS EQUIPMENT OR ITS BATTERIES, DO NOT USE THE ORDINARY WASTE BIN, AND DO NOT PUT THEM INTO A FIREPLACE!

Used electrical and electronic equipment and batteries should always be collected and treated SEPARATELY in accordance with local law.

Separate collection promotes an environment-friendly treatment, recycling of materials, and minimizing final disposal of waste. IMPROPER DISPOSAL can be harmful to human health and the environment due to certain substances! Take USED EQUIPMENT to a local, usually municipal, collection facility, where available.

Remove USED BATTERIES from equipment, and take them to a battery collection facility; usually a place where new batteries are sold.

If in doubt about disposal, contact your local authorities or dealer and ask for the correct method of disposal.

ONLY FOR USERS IN THE EUROPEAN UNION, AND SOME OTHER COUNTRIES; FOR INSTANCE NORWAY AND SWITZERLAND: Your participation in separate collection is requested by law.

The symbol shown above appears on electrical and electronic equipment and batteries (or the packaging) to remind users of this. If 'Hg' or 'Pb' appears below the symbol, this means that the battery contains traces of mercury (Hg) or lead (Pb), respectively.

Users from PRIVATE HOUSEHOLDS are requested to use existing return facilities for used equipment and batteries. Batteries are collected at points of sale. Return is free of charge.

If the equipment has been used for BUSINESS PURPOSES, please contact your SHARP dealer who will inform you about take-back. You might be charged for the costs arising from take-back. Small equipment (and small quantities) might be taken back by your local collection facility. For Spain: Please contact the established collection system or your local authority for take-back of your used products.

This equipment complies with the e-waste (Management and Handling) Rules, 2016. On restriction of the hazardous constituents as specified in rule 16 in electrical and electronic equipment. For more information to recycle properly, please see the website. <http://www.sbsil.com>.



WARNING: TO REDUCE THE RISK OF FIRE OR ELECTRIC SHOCK, DO NOT EXPOSE THIS PRODUCT TO RAIN OR MOISTURE.



CAUTION
RISK OF ELECTRIC SHOCK
DO NOT OPEN



The lightning flash with arrowhead symbol, within a triangle, is intended to alert the user to the presence of uninsulated "dangerous voltage" within the product's enclosure that may be of sufficient magnitude to constitute a risk of electric shock to persons.

CAUTION: TO REDUCE THE RISK OF ELECTRIC SHOCK, DO NOT REMOVE COVER. NO USER-SERVICEABLE PARTS INSIDE. REFER SERVICING TO QUALIFIED SERVICE PERSONNEL.



The exclamation point within a triangle is intended to alert the user to the presence of important operating and maintenance (servicing) instructions in the literature accompanying the product.

NOTE FOR USERS IN U.K. IMPORTANT

The wires in this mains lead are coloured in accordance with the following code:
BLUE: "NEUTRAL"
BROWN: "LIVE"

CONNECTING PLUG TO MAINS LEAD:

As the colours of the wires in the mains lead of this apparatus may not correspond with the coloured markings identifying the terminals in your plugs, proceed as follows:

- The wire which is coloured BLUE must be connected to the terminal which is marked with the letter N or coloured BLACK.
- The wire which is coloured BROWN must be connected to the terminal which is marked with the letter L or coloured RED.

CAUTION:

Do not connect the Live (BROWN) wire or the neutral (BLUE) wire to the earth terminal of your 3 pin mains plug.

Contents

1. Part Names
2. Basic Operation
3. Menu Operation
4. USB Media
5. AQUOS LINK and Other Devices
6. Operating the Monitor Using a PC (IP control)
7. Troubleshooting
8. Specifications, etc.

You can select an OSD language from among 7 languages.

English >>

Deutsch >>

Français >>

Italiano >>

Español >>

Русский >>

Polski >>

Ver. 1.15



DEAR SHARP CUSTOMER

Thank you for your purchase of a SHARP LCD product. To ensure safety and many years of trouble-free operation of your product, please read the Safety Precautions carefully before using this product.

SAFETY PRECAUTIONS

Electricity is used to perform many useful functions, but it can also cause personal injuries and property damage if improperly handled. This product has been engineered and manufactured with the highest priority on safety. However, improper use can result in electric shock and/or fire. In order to prevent potential danger, please observe the following instructions when installing, operating and cleaning the product. To ensure your safety and prolong the service life of your LCD product, please read the following precautions carefully before using the product.

1. Read instructions — All operating instructions must be read and understood before the product is operated.
2. Keep this manual in a safe place — These safety and operating instructions must be kept in a safe place for future reference.
3. Observe warnings — All warnings on the product and in the instructions must be observed closely.
4. Follow instructions — All operating instructions must be followed.
5. Cleaning — Unplug the power cord from the AC outlet before cleaning the product. Use a dry cloth to clean the product. Do not use liquid cleaners or aerosol cleaners. Do not use dirty cloths. Doing so may damage the product.
6. Attachments — Do not use attachments not recommended by the manufacturer. Use of inadequate attachments can result in accidents.
7. Water and moisture — Do not use the product near water. Do not install the product in a place where water may splash onto it. Be careful of equipment which drains water such as an air-conditioner.
8. Ventilation — The vents and other openings in the cabinet are designed for ventilation. Do not cover or block these vents and openings since insufficient ventilation can cause overheating and/or shorten the life of the product. Do not place the product on a sofa, rug or other similar surface, since they can block ventilation openings. Do not place the product in an enclosed place such as a bookcase or rack, unless proper ventilation is provided or the manufacturer's instructions are followed.
9. Power cord protection — The power cords must be routed properly to prevent people from stepping on them or objects from resting on them.
10. The LCD panel used in this product is made of glass. Therefore, it can break when the product is dropped or applied with impact. Be careful not to be injured by broken glass pieces in case the LCD panel breaks.
11. Overloading — Do not overload AC outlets or extension cords. Overloading can cause fire or electric shock.
12. Entering of objects and liquids — Never insert an object into the product through vents or openings. High voltage flows in the product, and inserting an object can cause electric shock and/or short internal parts. For the same reason, do not spill water or liquid on the product.
13. Servicing — Do not attempt to service the product yourself. Removing covers can expose you to high voltage and other dangerous conditions. Request a qualified service person to perform servicing.
14. Repair — If any of the following conditions occurs, unplug the power cord from the AC outlet, and request a qualified service person to perform repairs.
 - a. When the power cord or plug is damaged.
 - b. When a liquid was spilled on the product or when objects have fallen into the product.
 - c. When the product has been exposed to rain or water.
 - d. When the product does not operate properly as described in the operating instructions. Do not touch the controls other than those described in the operating instructions. Improper adjustment of controls not described in the instructions can cause damage, which often requires extensive adjustment work by a qualified technician.
 - e. When the product has been dropped or damaged.

SAFETY PRECAUTIONS

- f. When the product displays an abnormal condition. Any noticeable abnormality in the product indicates that the product needs servicing.
15. Replacement parts — In case the product needs replacement parts, make sure that the service person uses replacement parts specified by the manufacturer, or those with the same characteristics and performance as the original parts. Use of unauthorized parts can result in fire, electric shock and/or other danger.
16. Safety checks — Upon completion of service or repair work, request the service technician to perform safety checks to ensure that the product is in proper operating condition.
17. Wall mounting — When mounting the product on a wall, be sure to install the product according to the method recommended by the manufacturer.
18. Heat sources — Keep the product away from heat sources such as radiators, heaters, stoves and other heat-generating products (including amplifiers).
19. Batteries — Incorrect use of batteries may cause the batteries to burst or ignite. A leaky battery may corrode the equipment, dirty your hands or spoil your clothing. In order to avoid these problems, make sure to observe the precautions below:
 - Use the specified batteries only.
 - Install the batteries with due attention to the plus (+) and minus (-) sides of the batteries according to the instructions in the compartment.
 - Do not mix old and new batteries.
 - Do not mix batteries of different types. Voltage specifications of batteries of the same shape may vary.
 - Replace an exhausted battery with a new one promptly.
 - If you will not use the remote control for a long time, remove the batteries.
 - If leaked battery fluid gets on your skin or clothing, rinse immediately and thoroughly. If it gets into your eye, bathe your eye well rather than rubbing and seek medical treatment immediately. Leaked battery fluid that gets into your eye or your clothing may cause a skin irritation or damage your eye.
20. Usage of the Monitor must not be accompanied by fatal risks or dangers that, could lead directly to death, personal injury, severe physical damage or other loss, including nuclear reaction control in nuclear facility, medical life support system, and missile launch control in a weapon system.
21. Do not stay in contact with the parts of the product that become hot for long periods of time. Doing so may result in low-temperature burns.
22. Do not modify this product.
23. Do not place vases or any other water-filled containers on this product.

WARNING:

To prevent the spread of fire, keep candles or other open flames away from this product at all times.



WARNING:

This is a Class A product. In a domestic environment this product may cause radio interference in which case the user may be required to take adequate measures.

To maintain compliance with EMC regulations, use shielded cables to connect to the following terminals: PC/AV HDMI input terminal.

Where the mains plug or an appliance coupler is used as the disconnect device, the disconnect device shall remain readily operable.

Contents

1. Part Names
2. Basic Operation
3. Menu Operation
4. USB Media
5. AQUOS LINK and Other Devices
6. Operating the Monitor Using a PC (IP control)
7. Troubleshooting
8. Specifications, etc.

You can select an OSD language from among 7 languages.

English >>

Deutsch >>

Français >>

Italiano >>

Español >>

Русский >>

Polski >>

Ver. 1.15



WARNING

If a Monitor is not positioned in a sufficiently stable location, it can be potentially hazardous due to falling. Many injuries, particularly to children, can be avoided by taking simple precautions such as:

- Using fixing devices like wall mount brackets recommended by the manufacturer.
- Only using furniture that can safely support the Monitor.
- Ensuring the Monitor is not overhanging the edge of the supporting furniture.
- Not placing the Monitor on tall furniture (for example, cupboards or bookcases) without anchoring both the furniture and the Monitor to a suitable support.
- Not standing the Monitor on cloth or other materials placed between the Monitor and supporting furniture.
- Educating children about the dangers of climbing on furniture to reach the Monitor or its controls.
- If your existing product is being retained and relocated, the same considerations as above should be applied.

Especially for child safety

- Don't allow children to climb on or play with the Monitor.
- Don't place the Monitor on furniture that can easily be used as steps, such as a chest of drawers.
- Remember that children can become excited while watching a program, especially on a "larger than life" Monitor. Care should be taken to place or install the Monitor where it cannot be pushed, pulled over, or knocked down.
- Care should be taken to route all cords and cables connected to the Monitor so that they cannot be pulled or grabbed by curious children.

TIPS AND SAFETY INSTRUCTIONS

- The TFT color LCD panel used in this Monitor is made with the application of high precision technology. However, there may be minute points on the screen where pixels never light or are permanently lit. Also, if the screen is viewed from an acute angle there may be uneven colors or brightness. Please note that these are not malfunctions but common phenomena of LCDs and will not affect the performance of the Monitor.
- Do not display a still picture for a long period, as this could cause a residual image.
- Never rub or tap the Monitor with hard objects.
- Please understand that SHARP CORPORATION bears no responsibility for errors made during use by the customer or a third party, nor for any other malfunctions or damage to this product arising during use, except where indemnity liability is recognized under law.
- This Monitor and its accessories may be upgraded without advance notice.
- Do not use the Monitor where there is a lot of dust, where humidity is high, or where the Monitor may come into contact with oil or steam. Do not use in an environment where there are corrosive gases (sulfur dioxide, hydrogen sulfide, nitrogen dioxide, chlorine, ammonia, ozone, etc.). As this could lead to fire.
- Ensure that the Monitor does not come into contact with water or other fluids. Ensure that no objects such as paper clips or pins enter the Monitor as this could lead to fire or electric shock.
- Do not place the Monitor on top of unstable objects or in unsafe places. Do not allow the Monitor to receive strong shocks or to strongly vibrate. Causing the Monitor to fall or topple over may damage it.
- Do not use the Monitor near heating equipment or in places where there is likelihood of high temperature, as this may lead to generation of excessive heat and outbreak of fire.
- Do not use the Monitor in places where it may be exposed to direct sunlight.
- Please be sure to constantly remove dust and garbage that has attached to the ventilation opening. If dust collects in the ventilation opening or the inside of the Monitor, it may lead to excessive heat, outbreak of fire, or malfunction. Please request a cleaning of the inside of the Monitor from an authorized SHARP servicing dealer or service center.
- Images cannot be rotated on this Monitor. When using in portrait orientation, you will need to prepare appropriately orientated content in advance.
- The AC outlet shall be installed near the equipment and shall be easily accessible.

TIPS AND SAFETY INSTRUCTIONS

The Power Cord

- Use only the power cord supplied with the Monitor.
- Do not damage the power cord nor place heavy objects on it, stretch it or over bend it. Also, do not add extension cords. Damage to the cord may result in fire or electric shock.
- Do not use the power cord with a power tap. Adding an extension cord may lead to fire as a result of overheating.
- Do not remove or insert the power plug with wet hands. Doing so could result in electric shock.
- Unplug the power cord if it is not used for a long time.
- Do not attempt to repair the power cord if it is broken or malfunctioning. Refer the servicing to the service representative.

LED Backlight

- The LED backlight in this product has a limited lifetime.
- * If the screen gets dark or does not turn on, it may be necessary to replace the LED backlight.
- * This LED backlight is exclusive to this product and must be replaced by an authorized SHARP servicing dealer or service center. Please contact an authorized SHARP servicing dealer or service center for assistance.

MOUNTING PRECAUTIONS

- This product is for use indoors.
- A mounting bracket compliant with VESA specifications is required.
- Since the Monitor is heavy, consult your dealer before installing, removing or moving the Monitor.
- Mounting the Monitor on the wall requires special expertise and the work must be performed by an authorized SHARP dealer. You should never attempt to perform any of this work yourself. Our company will bear no responsibility for accidents or injuries caused by improper mounting or mishandling.
- Use the Monitor with the surface perpendicular to a level surface. If necessary, the Monitor may be tilted up to 20 degrees upward or downward.
- This Monitor should be used at an ambient temperature between 0°C and 35°C. Provide enough space around the Monitor to prevent heat from accumulating inside.
- If it is difficult to provide sufficient space for any reason such as the installation of the Monitor inside a housing, or if the ambient temperature may be outside of the range of 0°C to 35°C, install a fan or take other measures to keep the ambient temperature within the required range.
- Temperature condition may change when using the Monitor together with the optional equipments recommended by SHARP. In such cases, please check the temperature condition specified by the optional equipments.
- Do not block any ventilation openings. If the temperature inside the Monitor rises, this could lead to a malfunction.
- Do not place the Monitor on a device which generates heat.

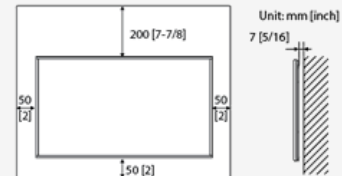

Contents

1. Part Names
2. Basic Operation
3. Menu Operation
4. USB Media
5. AQUOS LINK and Other Devices
6. Operating the Monitor Using a PC (IP control)
7. Troubleshooting
8. Specifications, etc.

You can select an OSD language from among 7 languages.

English >>

Deutsch >>

Français >>

Italiano >>

Español >>

Русский >>

Polski >>

Ver. 1.15



Part Names

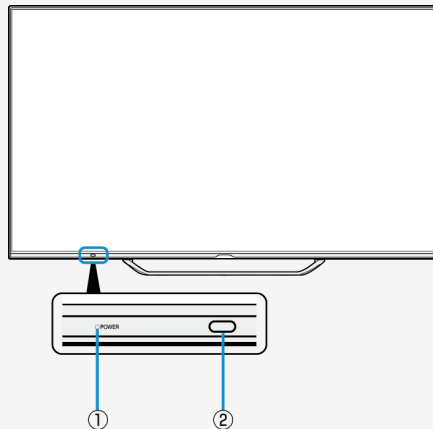

Monitor

Front

Name		Page
1	POWER lamp <ul style="list-style-type: none"> • Lit green: operating state • Lit red: standby state • Unlit: power-off state 	2-3
2	Remote control light receiving section <ul style="list-style-type: none"> • Point the remote control toward this section. 	—

Contents

1. Part Names
2. Basic Operation
3. Menu Operation
4. USB Media
5. AQUOS LINK and Other Devices
6. Operating the Monitor Using a PC (IP control)
7. Troubleshooting
8. Specifications, etc.

You can select an OSD language from among 7 languages.

English >>

Deutsch >>

Français >>

Italiano >>

Español >>

Русский >>

Polski >>

Ver. 1.15



Part Names

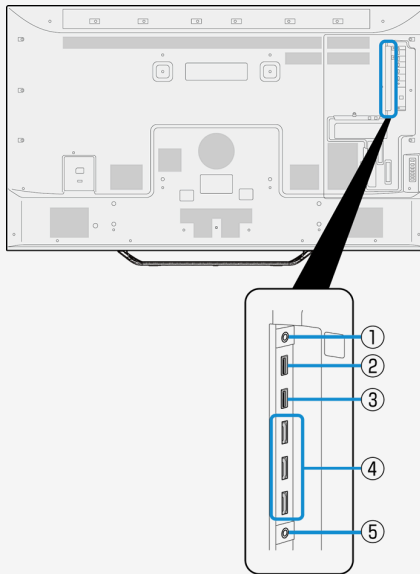

Monitor

Rear

	Name	Page
1	Headphone terminal (Ø 3.5, stereo mini jack) <ul style="list-style-type: none"> It allows sounds to come out from the speakers even after headphones are connected. 	3-34
2	USB1 terminal <ul style="list-style-type: none"> Connect USB memory. You can enjoy photo / music / video files stored in USB memory on the Monitor. You can use the multimedia auto play function. 	3-4 to 4-1
3	USB2 terminal <ul style="list-style-type: none"> Connect USB memory. You can enjoy photo / music / video files stored in USB memory on the Monitor. You can use the multimedia auto play function. 	—
4	INPUT 1 to 3 (HDMI) <ul style="list-style-type: none"> Connect 4K or 2K output HDMI compatible device. 	5-1 to 5-9 , 5-15 , 5-17 , 5-18 , 5-31 , 5-32
5	INPUT 5 (AV input) (dual as INPUT 1 / INPUT 6 / INPUT 7 audio input) <ul style="list-style-type: none"> Connect the analog audio output from a video game console, video camera or 8K video device. Be sure to use the supplied conversion cable. When using any conversion cable other than the supplied one, the Monitor may not operate properly, or a part may be broken. 	3-35 , 5-19 , 5-31 , 5-32 , 5-33

Contents

1. Part Names
2. Basic Operation
3. Menu Operation
4. USB Media
5. AQUOS LINK and Other Devices
6. Operating the Monitor Using a PC (IP control)
7. Troubleshooting
8. Specifications, etc.

You can select an OSD language from among 7 languages.

English >>

Deutsch >>

Français >>

Italiano >>

Español >>

Русский >>

Polski >>

Ver. 1.15



Part Names

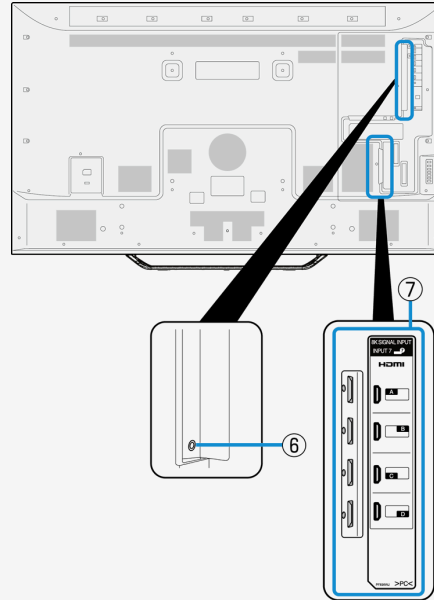

Monitor

Rear

	Name	Page
6	Analogue audio output terminal • Connect the audio device.	5-26
7	INPUT 7 A to D (HDMI) • Connect 8K image output compatible device.	5-1 , 5-2

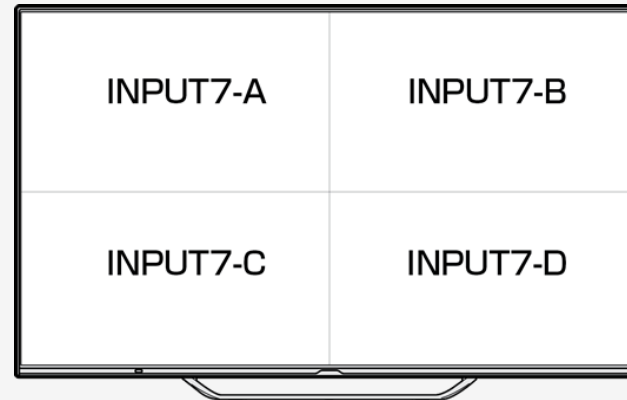

Contents

1. Part Names
2. Basic Operation
3. Menu Operation
4. USB Media
5. AQUOS LINK and Other Devices
6. Operating the Monitor Using a PC (IP control)
7. Troubleshooting
8. Specifications, etc.

You can select an OSD language from among 7 languages.

English >>

Deutsch >>

Français >>

Italiano >>

Español >>

Русский >>

Polski >>

Ver. 1.15



Part Names

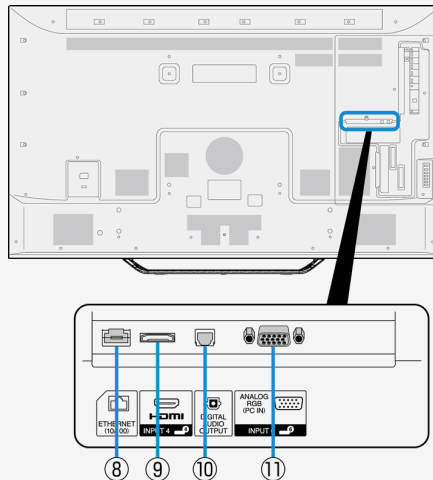

Monitor

Rear

	Name	Page
8	LAN terminal (10BASE-T / 100BASE-TX) • Used for home network, etc.	—
9	INPUT 4 (HDMI) • Connect 4K or 2K output HDMI compatible device.	5-1 to 5-6 , 5-15 , 5-17 , 5-18 , 5-32
10	Digital audio output (optical) terminal • Connect the audio device.	5-6
11	INPUT 6 (Analogue RGB) • Connect with the analogue RGB terminal for a computer.	5-33

Contents

1. Part Names
2. Basic Operation
3. Menu Operation
4. USB Media
5. AQUOS LINK and Other Devices
6. Operating the Monitor Using a PC (IP control)
7. Troubleshooting
8. Specifications, etc.

You can select an OSD language from among 7 languages.

English >>

Deutsch >>

Français >>

Italiano >>

Español >>

Русский >>

Polski >>

Ver. 1.15



Part Names

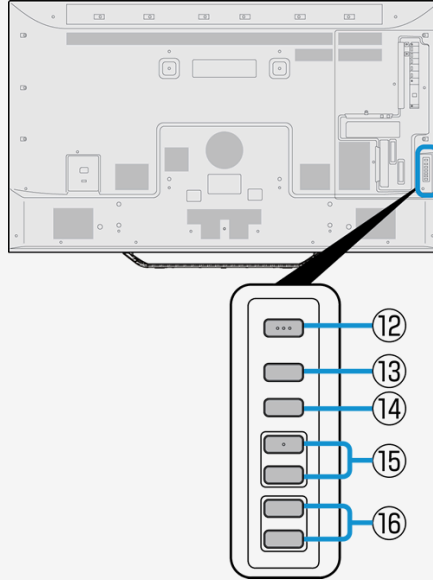

Monitor

Rear

	Name	Page
12	Power button	2-3
13	MENU button <ul style="list-style-type: none"> • Displays the menu. 	3-2
14	INPUT button <ul style="list-style-type: none"> • When in the Menu, this functions as the OK button. 	1-6
15	▲ forward / ▼ backward button <ul style="list-style-type: none"> • When Menu is operated, it is used as ▲ and ▼ cursor. 	1-6
16	Volume (+ / -) button <ul style="list-style-type: none"> • When Menu is operated, it is used as right-left cursor. • When in the Menu, this functions as the right-left cursor. 	1-6

Contents

1. Part Names
2. Basic Operation
3. Menu Operation
4. USB Media
5. AQUOS LINK and Other Devices
6. Operating the Monitor Using a PC (IP control)
7. Troubleshooting
8. Specifications, etc.

You can select an OSD language from among 7 languages.

English >>

Deutsch >>

Français >>

Italiano >>

Español >>

Русский >>

Polski >>

Ver. 1.15

Part Names

Monitor

Using the button of the Monitor to disable the child lock.

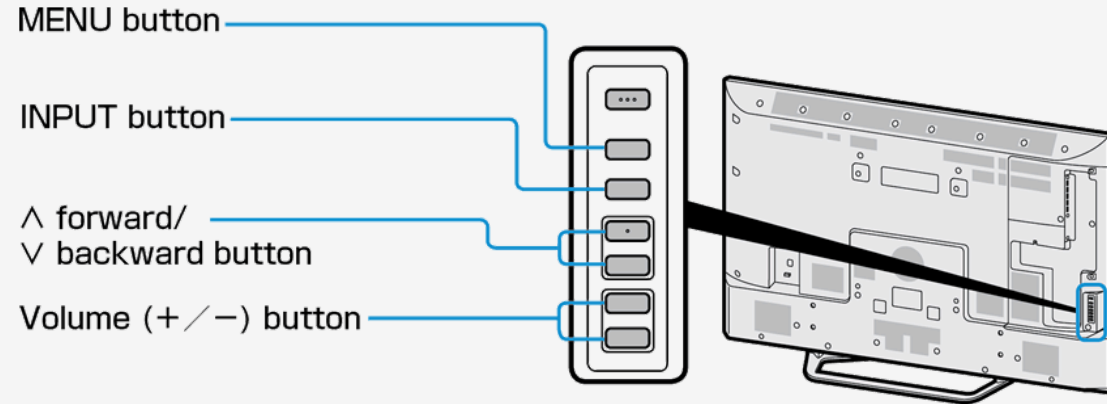

If "**The operation with remote control is prohibited**" appears on the screen use the operation button to unlock.

1. Press **MENU** on the Monitor.
2. Use the volume button on the Monitor to select "**Setup**" and then press **INPUT**.
3. Use the volume buttons and **^** forward / **v** backward on the Monitor to select "**Ecology**" - "**Child lock**" and press **INPUT**.
4. Select "**Off**" and press **INPUT**.

Contents

1. Part Names
2. Basic Operation
3. Menu Operation
4. USB Media
5. AQUOS LINK and Other Devices
6. Operating the Monitor Using a PC (IP control)
7. Troubleshooting
8. Specifications, etc.

You can select an OSD language from among 7 languages.

English >>
Deutsch >>
Français >>
Italiano >>
Español >>
Русский >>
Polski >>

Ver. 1.15

Part Names



Name of Remote Control Buttons

	Button name	Page
1	POWER	2-3
2	DISPLAY • Display the information.	—
3	SLEEP	—

Contents

1. Part Names
2. Basic Operation
3. Menu Operation
4. USB Media
5. AQUOS LINK and Other Devices
6. Operating the Monitor Using a PC (IP control)
7. Troubleshooting
8. Specifications, etc.

You can select an OSD language from among 7 languages.

English >>
Deutsch >>
Français >>
Italiano >>
Español >>
Русский >>
Polski >>

Ver. 1.15

Part Names



Name of Remote Control Buttons

	Button name	Page
4	Number • Also used to enter characters or numbers and perform the setup operations.	—
5	VOL +/-	—
6	AUDIO	2-3
7	MUTE	—
8	INPUT • Also used to change the input source to PC, USB media, etc.	5-22 , 5-30
9	CH	—

Contents

1. Part Names
2. Basic Operation
3. Menu Operation
4. USB Media
5. AQUOS LINK and Other Devices
6. Operating the Monitor Using a PC (IP control)
7. Troubleshooting
8. Specifications, etc.

You can select an OSD language from among 7 languages.

English >>
Deutsch >>
Français >>
Italiano >>
Español >>
Русский >>
Polski >>

Ver. 1.15

Part Names



Name of Remote Control Buttons

	Button name	Page
10	▲▼◀▶, ENTER • Used for the menu, character entry, etc.	3-2 , 3-45
11	EXIT • Used to quit the menu, character entry, etc.	3-2 , 3-45
12	APPS	3-2
13	MENU	3-44
14	RETURN • Used for the menu, character entry, etc.	3-2 , 3-45

Contents

1. Part Names
2. Basic Operation
3. Menu Operation
4. USB Media
5. AQUOS LINK and Other Devices
6. Operating the Monitor Using a PC (IP control)
7. Troubleshooting
8. Specifications, etc.

You can select an OSD language from among 7 languages.

English >>
Deutsch >>
Français >>
Italiano >>
Español >>
Русский >>
Polski >>

Ver. 1.15

Part Names



Name of Remote Control Buttons

	Button name	Page
15	OPTION	5-11 to 5-14
16	A/B/C/D • Operation for character entry	3-45

Contents

1. Part Names
2. Basic Operation
3. Menu Operation
4. USB Media
5. AQUOS LINK and Other Devices
6. Operating the Monitor Using a PC (IP control)
7. Troubleshooting
8. Specifications, etc.

You can select an OSD language from among 7 languages.

English >>
Deutsch >>
Français >>
Italiano >>
Español >>
Русский >>
Polski >>

Ver. 1.15



Basic Operation



Initial Installation

Perform the following steps before you press **POWER** on the remote control unit.

1. Insert the batteries into the remote control unit.
2. Plug in the AC cord to the AC outlet.

Language (Language setting)

Select from among 7 languages: English, French, Spanish, German, Italian, Russian and Polish.

1. Press **▲▼/◀▶** to select the desired language listed on the screen, and then press **ENTER**.

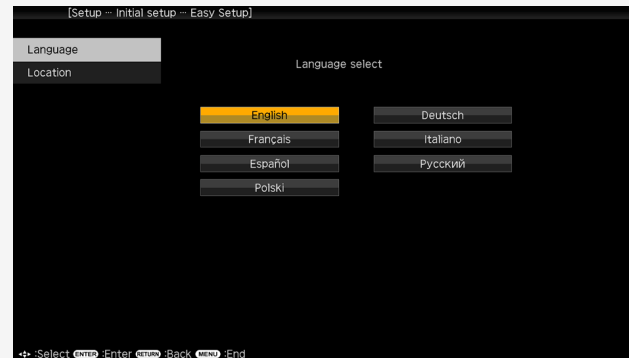

Contents

1. Part Names
2. Basic Operation
3. Menu Operation
4. USB Media
5. AQUOS LINK and Other Devices
6. Operating the Monitor Using a PC (IP control)
7. Troubleshooting
8. Specifications, etc.

You can select an OSD language from among 7 languages.

- English >>
- Deutsch >>
- Français >>
- Italiano >>
- Español >>
- Русский >>
- Polski >>

Ver. 1.15



Basic Operation



Initial Installation (Continue)

Location

Select your using location from home use or store use.

Select where this device is being used, between home use or as a shop display unit

2. Press to select location, and then press **ENTER**.

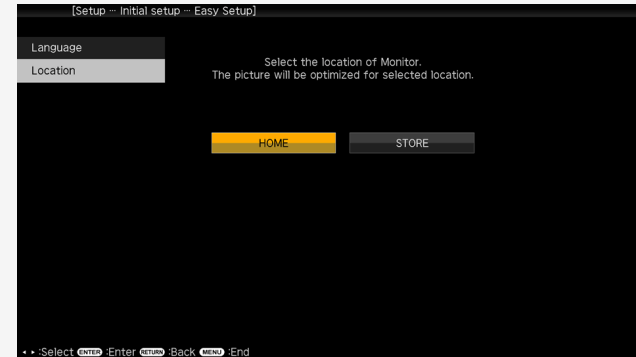

Contents

1. Part Names
2. Basic Operation
3. Menu Operation
4. USB Media
5. AQUOS LINK and Other Devices
6. Operating the Monitor Using a PC (IP control)
7. Troubleshooting
8. Specifications, etc.

You can select an OSD language from among 7 languages.

- English >>
- Deutsch >>
- Français >>
- Italiano >>
- Español >>
- Русский >>
- Polski >>

Ver. 1.15

Basic Operation



Basic Operation

1. Turn on the Monitor

- Each time you press the power button on the remote control turn on or off the Monitor.
- After pressing the power button on the rear side of the Monitor to turn "ON", the POWER lamp turns green.
- The POWER lamp will not disappear even though the power is turned off by pressing the power button on the Monitor. See "Power Button Setting" (Page [3-4](#)).

2. Adjust the volume

- Press "+" to turn the volume up, and "-" to turn it down.

Front side of the Monitor



POWER lamp

Contents

1. Part Names
2. Basic Operation
3. Menu Operation
4. USB Media
5. AQUOS LINK and Other Devices
6. Operating the Monitor Using a PC (IP control)
7. Troubleshooting
8. Specifications, etc.

You can select an OSD language from among 7 languages.

- English >>
- Deutsch >>
- Français >>
- Italiano >>
- Español >>
- Русский >>
- Polski >>

Ver. 1.15

Basic Operation



Using Timer

Turning off the power after a specified time (Sleep timer)

- This is useful for instance, to fall asleep while watching the Monitor.

Press **SLEEP**

- Each time you press **SLEEP**, the screen changes as follows.

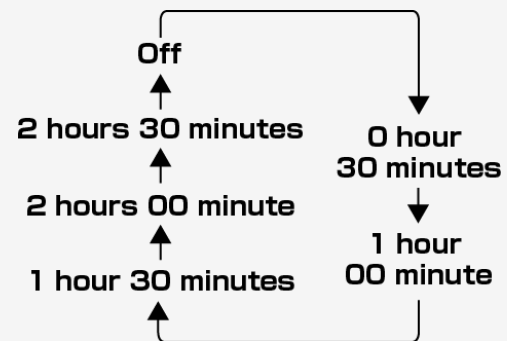

- 5 minutes before the power shuts down, the remaining time will be displayed on the bottom left of the screen.
- To disable the sleep timer, select "Off".

Contents

1. Part Names
2. Basic Operation
3. Menu Operation
4. USB Media
5. AQUOS LINK and Other Devices
6. Operating the Monitor Using a PC (IP control)
7. Troubleshooting
8. Specifications, etc.

You can select an OSD language from among 7 languages.

English >>
Deutsch >>
Français >>
Italiano >>
Español >>
Русский >>
Polski >>

Ver. 1.15

Basic Operation



Using Timer

Turning off the power after a specified time (Sleep timer)

To check the remaining time of the sleep timer

Press **APPS**

- If the sleep timer has already been set, the remaining time will be displayed.
- The display of remaining time will disappear after a while.
- Do not press the **APPS** during the display of the remaining time. Otherwise, the remaining time will be affected.

Contents

1. Part Names
2. Basic Operation
3. Menu Operation
4. USB Media
5. AQUOS LINK and Other Devices
6. Operating the Monitor Using a PC (IP control)
7. Troubleshooting
8. Specifications, etc.

You can select an OSD language from among 7 languages.

- English >>
- Deutsch >>
- Français >>
- Italiano >>
- Español >>
- Русский >>
- Polski >>

Ver. 1.15

Basic Operation

Listening with Headphones

Setting up the headphones

- Sets the audio sound that comes out of the speakers / headphone terminal during the use of headphones.
 1. Press **MENU** to display the home screen
 2. Press **▲▼/◀▶** to select "**Setup**", and then press **ENTER**
 3. Press **▲▼/◀▶** to select "**Option**" - "**Terminal setting**", and then press **ENTER**
 4. Press **▲▼** to select "**Headphone**", and then press **ENTER**
 5. Press **▲▼** to select any of "**Mode1**" or "**Mode2**", and then press **ENTER**
- For information on how to adjust the sound / volume of the speakers or headphone jack, see the following.

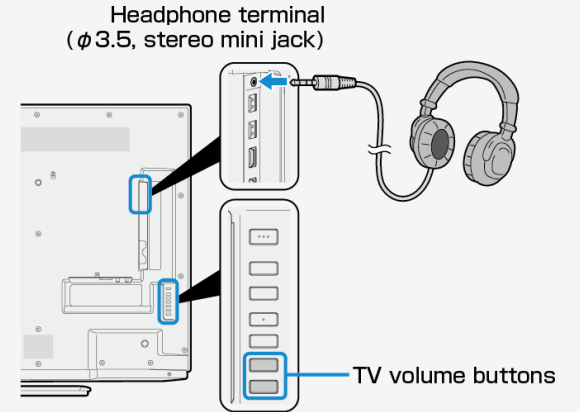

Setup	Sound output		Volume control method
	Headphone	Monitor's speaker	
Mode1	o	x	Adjust the volume by using the volume button on the remote control or the Monitor
Mode2	o	o	Adjust the headphone volume by using the volume button on the Monitor
			Adjust the speaker volume of the Monitor by using the volume button on the remote control

Contents

1. Part Names
2. Basic Operation
3. Menu Operation
4. USB Media
5. AQUOS LINK and Other Devices
6. Operating the Monitor Using a PC (IP control)
7. Troubleshooting
8. Specifications, etc.

You can select an OSD language from among 7 languages.

English >>
Deutsch >>
Français >>
Italiano >>
Español >>
Русский >>
Polski >>

Ver. 1.15



Menu Operation



How to Use Menu

- The screen that serves as a gateway to operating the Monitor is called the "Menu".
- This section describes how to use Menu.

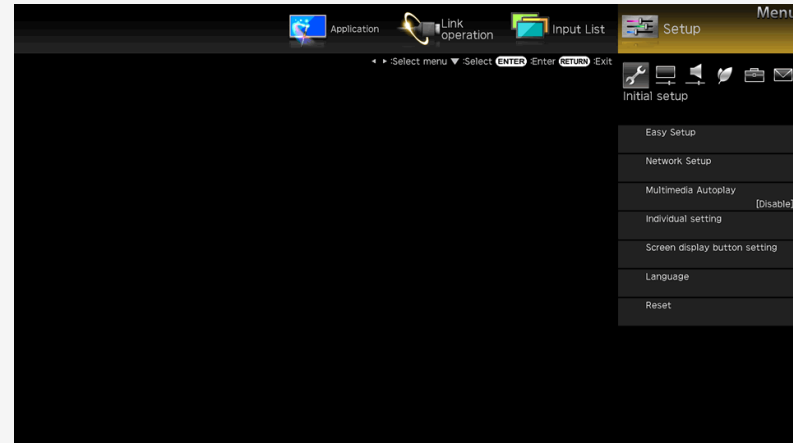

NOTE

- You can also use the buttons on the Monitor to operate the Menu.(page [1-5](#))

Contents

1. Part Names
2. Basic Operation
3. Menu Operation
4. USB Media
5. AQUOS LINK and Other Devices
6. Operating the Monitor Using a PC (IP control)
7. Troubleshooting
8. Specifications, etc.

You can select an OSD language from among 7 languages.

- English >>
- Deutsch >>
- Français >>
- Italiano >>
- Español >>
- Русский >>
- Polski >>

Ver. 1.15

Menu Operation



How to Use Setup Menu

Basic operation for using the setup menu

1. Press **MENU** to display the Menu, press **◀▶** to select "**Setup**", and then press **ENTER**

- If **◀▶** button is pressed, the Menu item can be selected as follows.

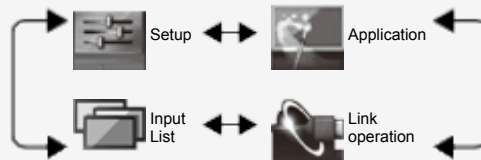

2. Press **▲▼◀▶** to select a desired item, and then press **ENTER**.

- Depending on the selected item, there may be further options to select from.

e.g.: for "**Setup**"

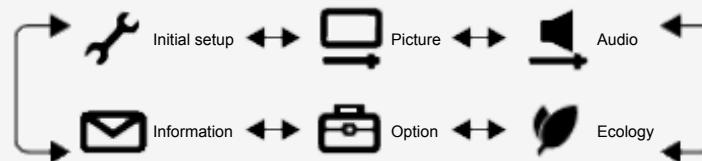

- To select the Menu item (step 1) again, press **RETURN**.

Contents

1. Part Names
2. Basic Operation
3. Menu Operation
4. USB Media
5. AQUOS LINK and Other Devices
6. Operating the Monitor Using a PC (IP control)
7. Troubleshooting
8. Specifications, etc.

You can select an OSD language from among 7 languages.

English >>
Deutsch >>
Français >>
Italiano >>
Español >>
Русский >>
Polski >>

Ver. 1.15



Menu Operation

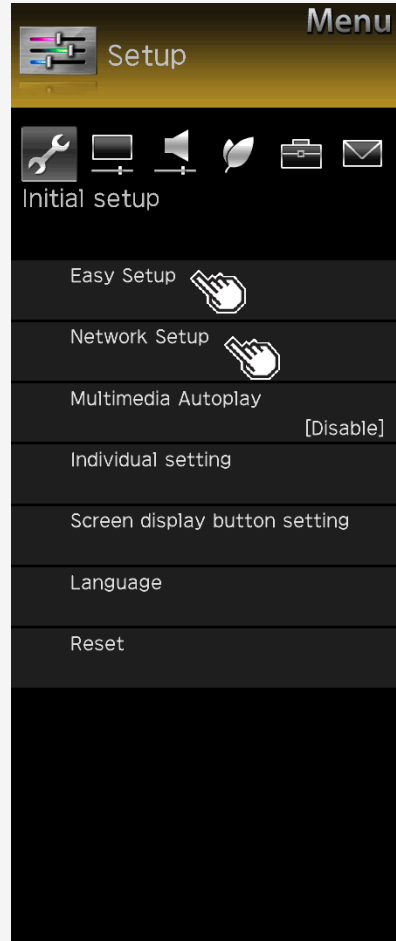

List of Setup Menu Items

Easy Setup

When you turn on the Monitor for the first time, the “**Easy Setup**” screen appears. Configure the setting by following onscreen instructions.

Menu item names
Language
Location

Network setup

IP control setup

- This setting is necessary when operating Monitor remotely using a mobile device or a personal computer.

Menu item names				Setup
Ethernet setup	Change	IP address	DNS IP address	Test, Complete
	Initialise			
IP control setup	IP control setup			Enable, Disable
	Detail setting	Change		Login ID, Password, Control port
		Initialise		

Contents

1. Part Names
2. Basic Operation
3. Menu Operation
4. USB Media
5. AQUOS LINK and Other Devices
6. Operating the Monitor Using a PC (IP control)
7. Troubleshooting
8. Specifications, etc.

You can select an OSD language from among 7 languages.

English >>
 Deutsch >>
 Français >>
 Italiano >>
 Español >>
 Русский >>
 Polski >>

Ver. 1.15



Menu Operation

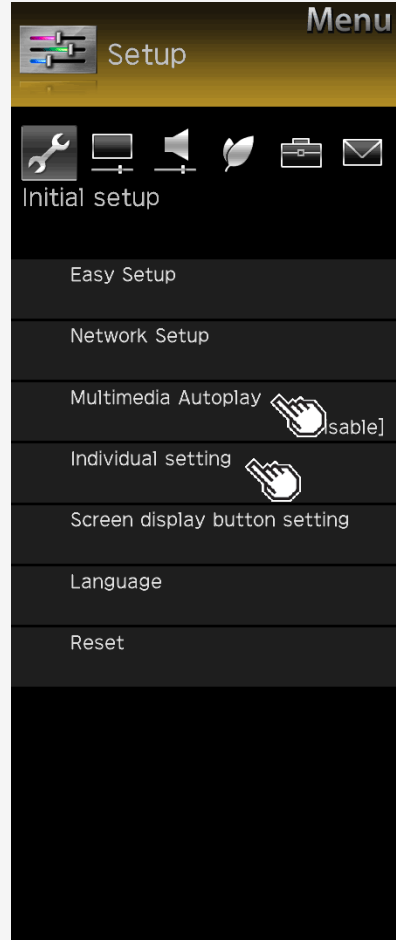

List of Setup Menu Items

Multimedia Autoplay

Playback the pictures in the USB memory automatically when power is turned on. Create a folder and name it as "autoplay", then put pictures into this folder.

Individual setting

Power button setting

- The power button on the Monitor can either power off the Monitor or set it to the standby state.

Menu item name	Setup	
Power button setting	Mode1	The remote control is always on standby mode.
	Mode2	Power will only turn on by the Main power button (not Remote Control).

Contents

1. Part Names
2. Basic Operation
3. Menu Operation
4. USB Media
5. AQUOS LINK and Other Devices
6. Operating the Monitor Using a PC (IP control)
7. Troubleshooting
8. Specifications, etc.

You can select an OSD language from among 7 languages.

English >>
Deutsch >>
Français >>
Italiano >>
Español >>
Русский >>
Polski >>

Ver. 1.15



Menu Operation

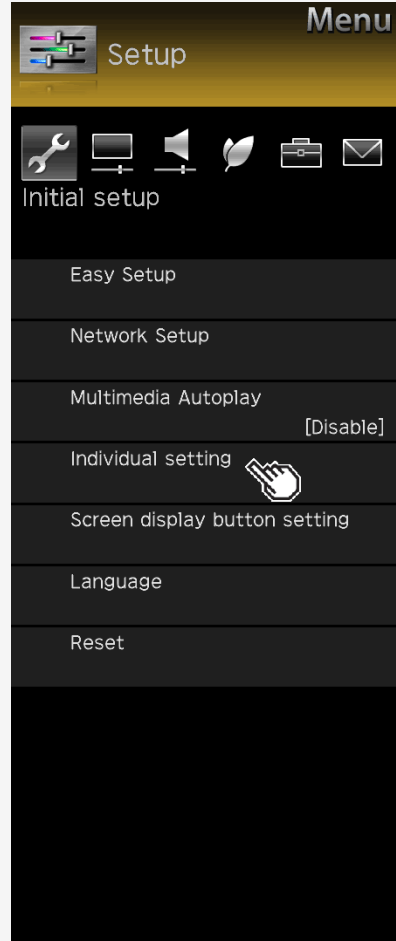

List of Setup Menu Items

Individual setting (Continue)

Standby Mode

- IP Control is active even during standby.

Menu item name	Setup	
Standby Mode	No	Go into normal standby.
	Yes (Always)	The standby power consumption will increase when "Yes" is selected.

USB memory setting

- This setting allows you to select a USB memory to be copied pictures.

Menu item name	Setup	
USB memory setting	Select USB memory	Select USB memory to use for copy
	Remove selected USB memory	Remove the selected USB memory

Contents

1. Part Names
2. Basic Operation
3. Menu Operation
4. USB Media
5. AQUOS LINK and Other Devices
6. Operating the Monitor Using a PC (IP control)
7. Troubleshooting
8. Specifications, etc.

You can select an OSD language from among 7 languages.

English >>
 Deutsch >>
 Français >>
 Italiano >>
 Español >>
 Русский >>
 Polski >>

Ver. 1.15



Menu Operation

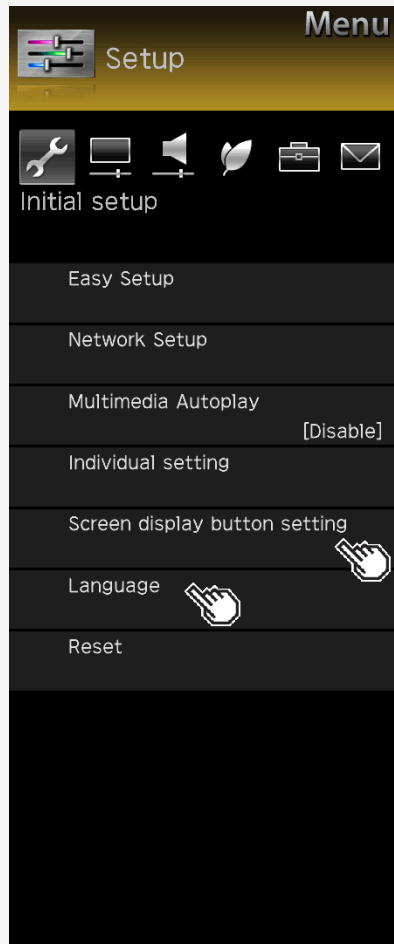

List of Setup Menu Items

Screen display button setting

- This setting allows you to choose the displayed information when you press **DISPLAY**.

Menu item name	Setup
Input display	Yes, During Input select, No
Input detail	Yes, During Input select, No
Sound/Screen info. Display	Yes, During Input select, No
Playback status display	Yes, During operation, No

Language

- Using the Menu screen, you can switch the on-screen display language to other languages.

Setup
English, Deutsch, Français, Italiano, Español, Русский, Polski

Contents

1. Part Names
2. Basic Operation
3. Menu Operation
4. USB Media
5. AQUOS LINK and Other Devices
6. Operating the Monitor Using a PC (IP control)
7. Troubleshooting
8. Specifications, etc.

You can select an OSD language from among 7 languages.

English >>

Deutsch >>

Français >>

Italiano >>

Español >>

Русский >>

Polski >>

Ver. 1.15



Menu Operation

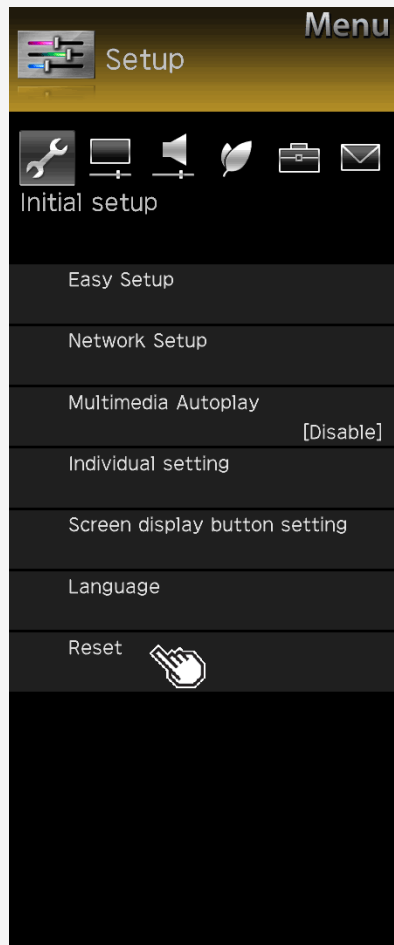

List of Setup Menu Items

Reset

- Before transferring or disposing the Monitor, erase all of your personal information. The information (various adjustment values, LAN setup, passwords, etc.) will be erased.

Contents

1. Part Names
2. Basic Operation
3. Menu Operation
4. USB Media
5. AQUOS LINK and Other Devices
6. Operating the Monitor Using a PC (IP control)
7. Troubleshooting
8. Specifications, etc.

You can select an OSD language from among 7 languages.

English >>
 Deutsch >>
 Français >>
 Italiano >>
 Español >>
 Русский >>
 Polski >>

Ver. 1.15



Menu Operation

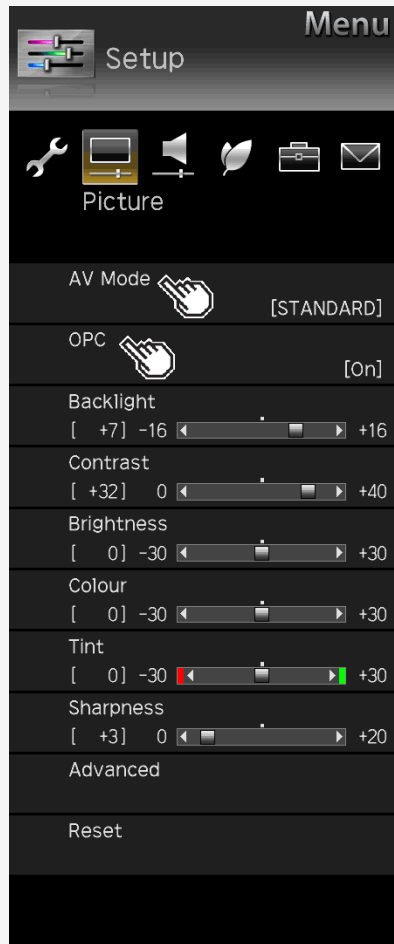

List of Setup Menu Items

AV Mode

- This function allows you to switch the video and sound to be more suitable for movies, games, etc.

Setup

STANDARD, MOVIE, USER, PC, MOVIE(HDR), PHOTO, DYNAMIC, DYNAMIC(Fixed)

You can also configure these settings from the Application menu(page [3-44](#))

OPC

- Sets to "On: Display" or "On" to automatically adjust the backlight brightness according to the lightness of the area surrounding Monitor, such as the indoor lighting conditions.

Setup

Off, On, On:Display

Contents

1. Part Names
2. Basic Operation
3. Menu Operation
4. USB Media
5. AQUOS LINK and Other Devices
6. Operating the Monitor Using a PC (IP control)
7. Troubleshooting
8. Specifications, etc.

You can select an OSD language from among 7 languages.

English >>
Deutsch >>
Français >>
Italiano >>
Español >>
Русский >>
Polski >>

Ver. 1.15



Menu Operation

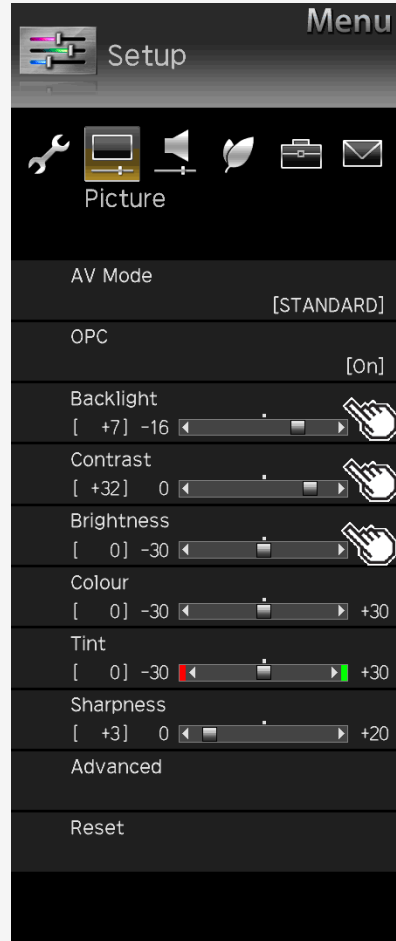

List of Setup Menu Items

Backlight

- You can adjust the backlight brightness.

Setup

-16 to 0 to +16

Contrast

- You can adjust the contrast.

Setup

0 to +40

Brightness

- You can adjust the brightness.

Setup

-30 to 0 to +30

Contents

1. Part Names
2. Basic Operation
3. Menu Operation
4. USB Media
5. AQUOS LINK and Other Devices
6. Operating the Monitor Using a PC (IP control)
7. Troubleshooting
8. Specifications, etc.

You can select an OSD language from among 7 languages.

English >>
Deutsch >>
Français >>
Italiano >>
Español >>
Русский >>
Polski >>

Ver. 1.15



Menu Operation

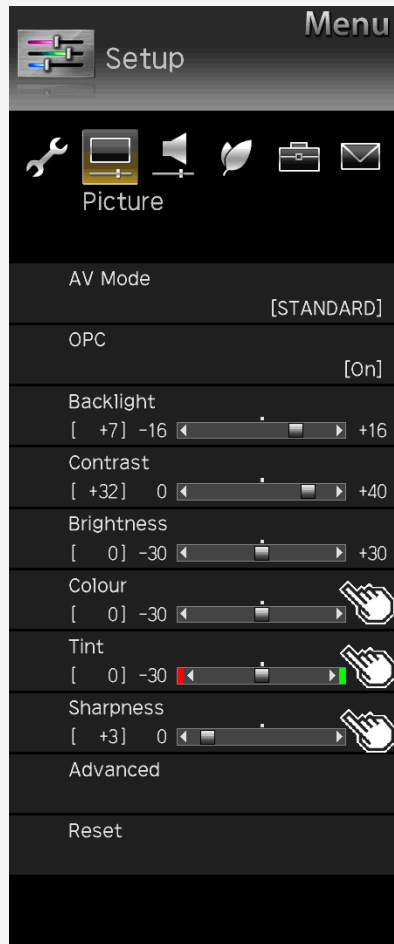

List of Setup Menu Items

Colour

- You can adjust the colour saturation.

Setup

-30 to 0 to +30

Tint

- You can adjust the colour tint.

Setup

-30 to 0 to +30

Sharpness

- You can adjust the sharpness.

Setup

0 to +20

Contents

1. Part Names
2. Basic Operation
3. Menu Operation
4. USB Media
5. AQUOS LINK and Other Devices
6. Operating the Monitor Using a PC (IP control)
7. Troubleshooting
8. Specifications, etc.

You can select an OSD language from among 7 languages.

English >>
Deutsch >>
Français >>
Italiano >>
Español >>
Русский >>
Polski >>

Ver. 1.15



Menu Operation

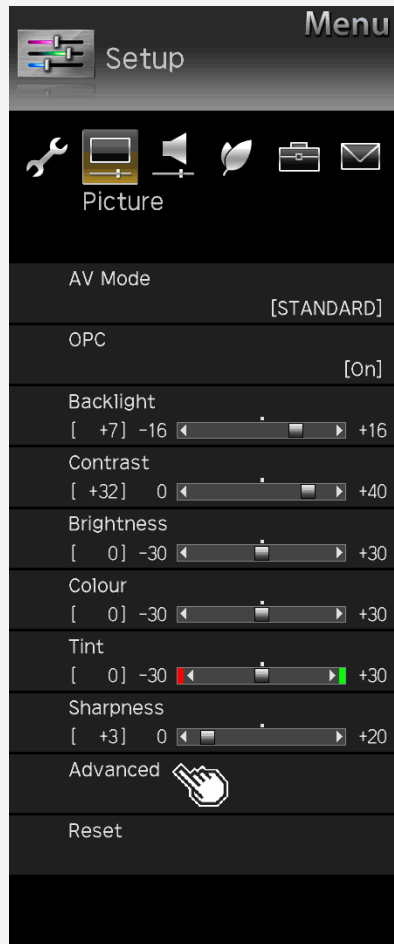

List of Setup Menu Items

Advanced

C.M.S.-hue

- Adjusts six-color hue.

Menu item name	Setup
C.M.S.-hue	R -30 to 0 to +30
	Y -30 to 0 to +30
	G -30 to 0 to +30
	C -30 to 0 to +30
	B -30 to 0 to +30
	M -30 to 0 to +30
Reset	

C.M.S.-saturation

- Adjusts six-color saturation.

Menu item name	Setup
C.M.S.-saturation	R -15 to 0 to +15
	Y -15 to 0 to +15
	G -15 to 0 to +15
	C -15 to 0 to +15
	B -15 to 0 to +15
	M -15 to 0 to +15
Reset	

Contents

1. Part Names
2. Basic Operation
3. Menu Operation
4. USB Media
5. AQUOS LINK and Other Devices
6. Operating the Monitor Using a PC (IP control)
7. Troubleshooting
8. Specifications, etc.

You can select an OSD language from among 7 languages.

English >>
Deutsch >>
Français >>
Italiano >>
Español >>
Русский >>
Polski >>

Ver. 1.15



Menu Operation

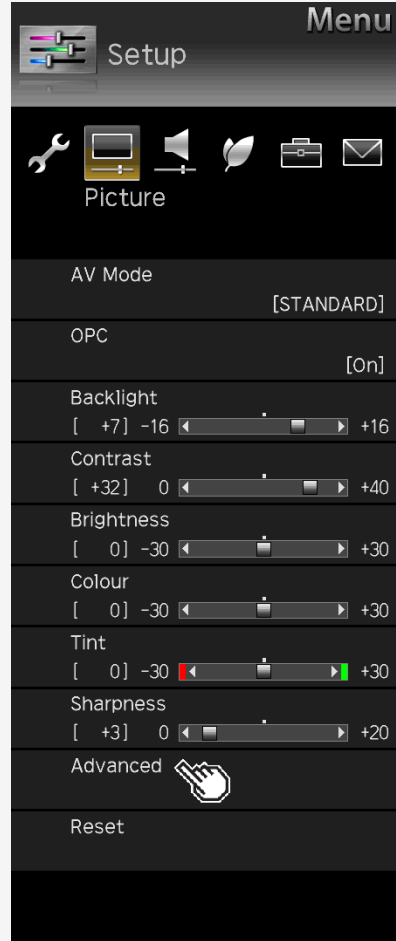

List of Setup Menu Items

Advanced (Continue)

C.M.S.-value

- Adjusts six-color image value.

Menu item name	Setup
C.M.S.-value	R -30 to 0 to +30
	Y -30 to 0 to +30
	G -30 to 0 to +30
	C -30 to 0 to +30
	B -30 to 0 to +30
	M -30 to 0 to +30
Reset	

Colour Gamut Range

- Sets the color reproduction range to be displayed.

Setup
Advanced, Standard, Compatibility mode

Contents

1. Part Names
2. Basic Operation
3. Menu Operation
4. USB Media
5. AQUOS LINK and Other Devices
6. Operating the Monitor Using a PC (IP control)
7. Troubleshooting
8. Specifications, etc.

You can select an OSD language from among 7 languages.

English >>
Deutsch >>
Français >>
Italiano >>
Español >>
Русский >>
Polski >>

Ver. 1.15



Menu Operation

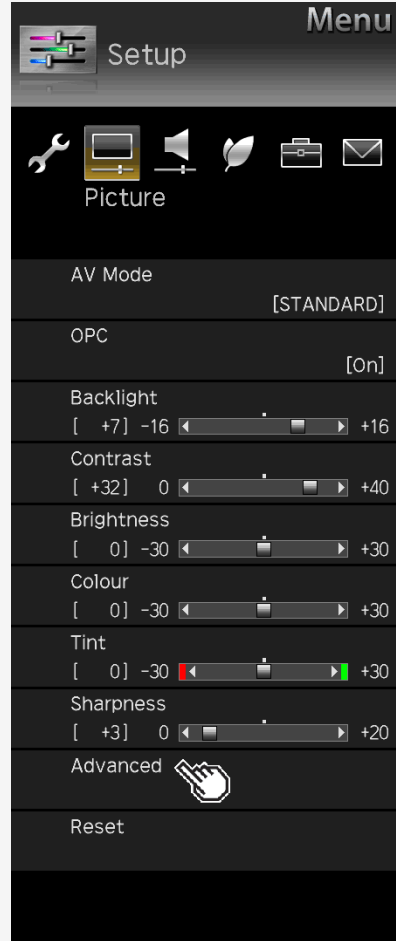

List of Setup Menu Items

Advanced (Continue)

Colour temp.

- You can make adjustments to make the color blueish white (color temperature; high) or redish white (color temperature: low). In addition, you can adjust the white balance by changing the R / G B gain values on a per-color temperature basis.

Menu item name	Setup	
Colour temperature	Colour temp.	High, Middle, Low
	R Gain(LO)	-30 to 0 to +30
	G Gain(LO)	-30 to 0 to +30
	B Gain(LO)	-30 to 0 to +30
	R Gain(HI)	-30 to 0 to +30
	G Gain(HI)	-30 to 0 to +30
	B Gain(HI)	-30 to 0 to +30
	Reset	

Contents

1. Part Names
2. Basic Operation
3. Menu Operation
4. USB Media
5. AQUOS LINK and Other Devices
6. Operating the Monitor Using a PC (IP control)
7. Troubleshooting
8. Specifications, etc.

You can select an OSD language from among 7 languages.

English >>
Deutsch >>
Français >>
Italiano >>
Español >>
Русский >>
Polski >>

Ver. 1.15



Menu Operation

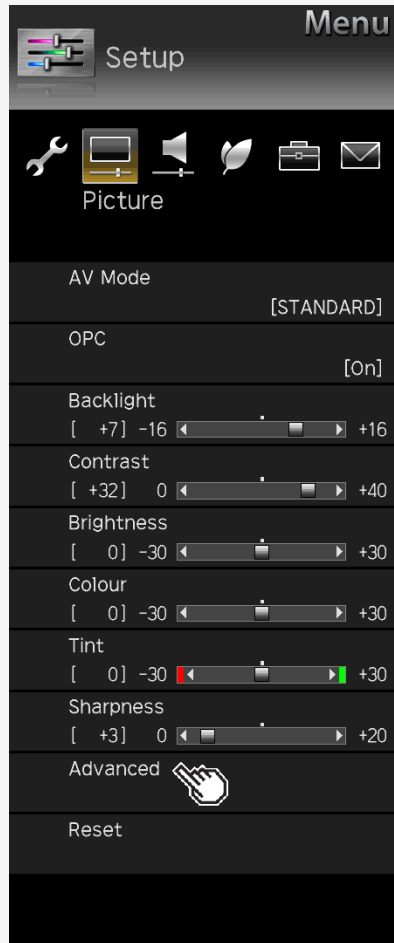

List of Setup Menu Items

Advanced (Continue)

Resolution*

- High definition video with sharper images

Menu item name	Setup
Details	0 to +10
Narrow edge	0 to +10
Wide edge	0 to +10

HDR-SDR Switch*

Menu item name	Setup
Auto	Select HDR/SDR mode automatically.
HLG	Setting dynamic range to HLG(HDR).
PQ	Setting dynamic range to PQ(HDR).
SDR	Setting dynamic range to SDR.

Dynamic range expand setting

- Sets the local dimming control and the peak brightness.
Enhances the contrast through the use of area-driven backlight.

Setup
0 to +6

NOTE

*Not selectable depending on INPUT or AV mode.

Contents

1. Part Names
2. Basic Operation
3. Menu Operation
4. USB Media
5. AQUOS LINK and Other Devices
6. Operating the Monitor Using a PC (IP control)
7. Troubleshooting
8. Specifications, etc.

You can select an OSD language from among 7 languages.

English >>
Deutsch >>
Français >>
Italiano >>
Español >>
Русский >>
Polski >>

Ver. 1.15



Menu Operation

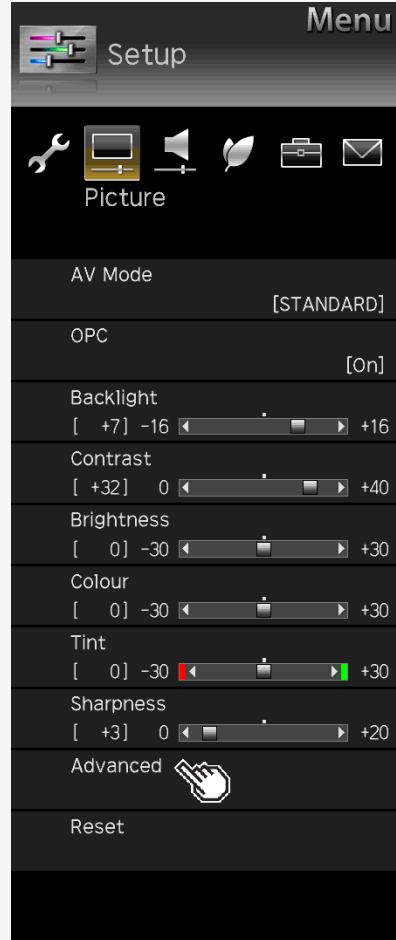

List of Setup Menu Items

Advanced (Continue)

Menu item name	Setup	
Active contrast*	On, Off	The video contrast can be automatically adjusted according to the scene.
Gamma adjustment*	-3 to 0 to +3	The difference in tone between the bright and dark sections of a video image can be adjusted.
HDR(PQ) Gamma Setting*	-2 to 0 to +2	
Living room view	On, Off	Intended to control the tone expression, allowing for extensive viewing
Input range setting	Auto, Full, Limited	

NOTE

*Not selectable depending on INPUT or AV mode.

Contents

1. Part Names
2. Basic Operation
3. Menu Operation
4. USB Media
5. AQUOS LINK and Other Devices
6. Operating the Monitor Using a PC (IP control)
7. Troubleshooting
8. Specifications, etc.

You can select an OSD language from among 7 languages.

English >>
Deutsch >>
Français >>
Italiano >>
Español >>
Русский >>
Polski >>

Ver. 1.15



Menu Operation

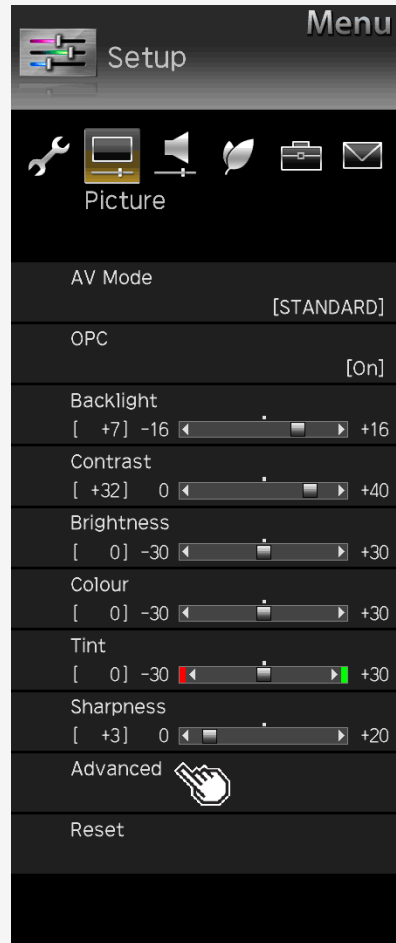

List of Setup Menu Items

Advanced (Continue)

Film mode*1*2*3*4*5

- Intended to play back videos, such as films on a DVD, whose original signal is 24 images per second at high image quality.

DNR*1*4*5

- This function reduces the noise in the video, smoothening the video.

Menu item name	Setup
Film mode	Advanced(High), Advanced(Low), Standard, Off
DNR	Auto, High, Middle, Low, Off

NOTE

- *1 Not selectable depending on INPUT or AV mode.
- *2 This is not selectable at any time when the input signal is progressive (480p, 720p, 1080p, 2160p).
- *3 This is not selectable at any times when the input signal is PC signal.
- *4 Not selectable depending on the screen viewed.
- *5 The effect may not be discernible depending on the input signal type or video contents.

Contents

1. Part Names
2. Basic Operation
3. Menu Operation
4. USB Media
5. AQUOS LINK and Other Devices
6. Operating the Monitor Using a PC (IP control)
7. Troubleshooting
8. Specifications, etc.

You can select an OSD language from among 7 languages.

English >>
Deutsch >>
Français >>
Italiano >>
Español >>
Русский >>
Polski >>

Ver. 1.15



Menu Operation

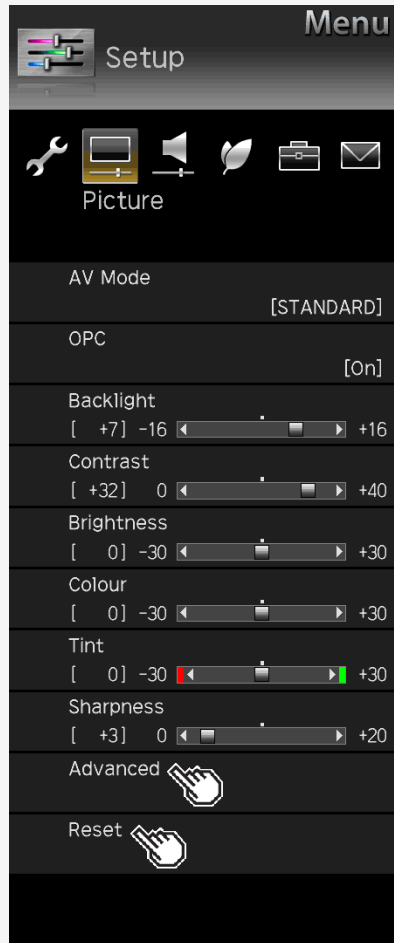

List of Setup Menu Items

Advanced (Continue)

Range of OPC

- You can set the desired maximum / minimum values for the operational sensitivity range when the brightness sensor (OPC) is set to "ON". The brightness sensor does not work if the set range is narrow, but it depends on the brightness of the surrounding area.

Item name	Setup	
Range of OPC	Max.	-16 to 0 to +16
	Min.	-16 to 0 to +16

Reset

- Resets all video adjustments to factory defaults.

Setup
Yes, No

Contents

1. Part Names
2. Basic Operation
3. Menu Operation
4. USB Media
5. AQUOS LINK and Other Devices
6. Operating the Monitor Using a PC (IP control)
7. Troubleshooting
8. Specifications, etc.

You can select an OSD language from among 7 languages.

English >>
 Deutsch >>
 Français >>
 Italiano >>
 Español >>
 Русский >>
 Polski >>

Ver. 1.15



Menu Operation

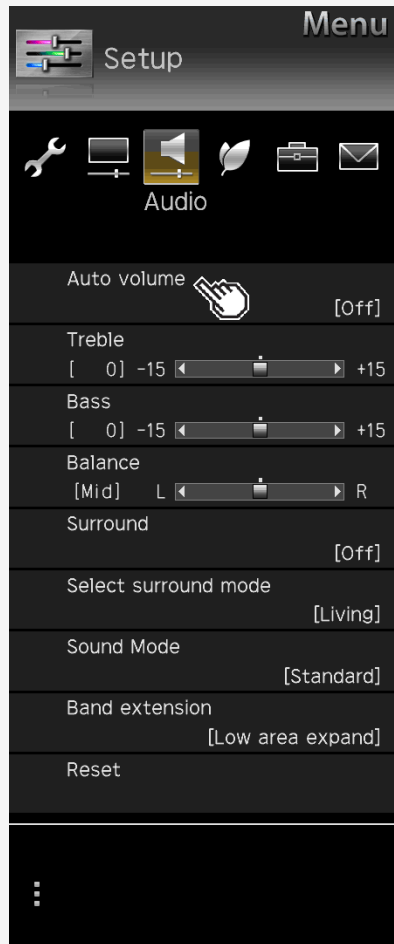

List of Setup Menu Items

Auto volume

- If the volume level differs in the same input, you can set to adjust the volume automatically.

Setup	
High	Volume range will be kept very narrow.
Middle	Volume range will be kept narrow.
Low	Volume range will be kept slightly narrow.
Off	This function is disabled. Volume range will be kept as original.

NOTE

- If the **Clear voice** setup is set to "**Standard**", "**Mild**" or "**Clear**", **Auto volume** is automatically set and cannot be changed.
- This function works only for the audio sounds output from the Monitor's speakers. It does not work for any audio sounds from headphones or external speakers.
- This function may not be effective enough depending on the contents.

Contents

1. Part Names
2. Basic Operation
3. Menu Operation
4. USB Media
5. AQUOS LINK and Other Devices
6. Operating the Monitor Using a PC (IP control)
7. Troubleshooting
8. Specifications, etc.

You can select an OSD language from among 7 languages.

English >>

Deutsch >>

Français >>

Italiano >>

Español >>

Русский >>

Polski >>

Ver. 1.15



Menu Operation

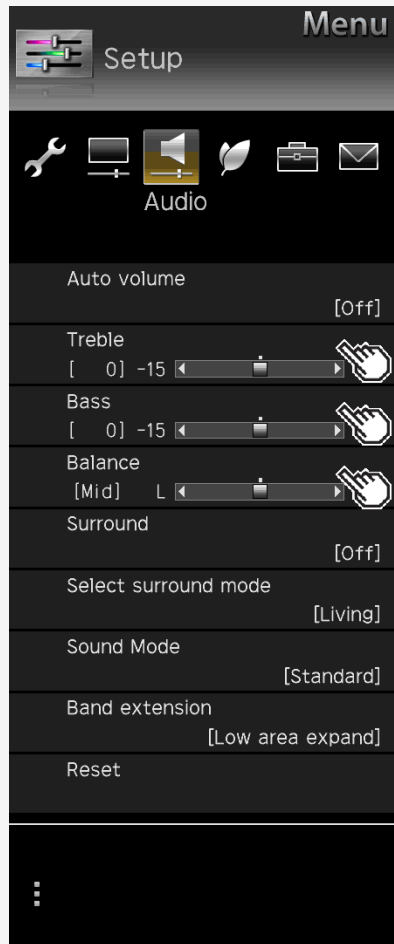

List of Setup Menu Items

Treble

- You can adjust Treble

Setup

-15 to 0 to +15

Bass

- You can adjust Bass

Setup

-15 to 0 to +15

Balance

- You can adjust the balance of the speaker volume for both left and right.

Setup

L30 to Mid to R30

Contents

1. Part Names
2. Basic Operation
3. Menu Operation
4. USB Media
5. AQUOS LINK and Other Devices
6. Operating the Monitor Using a PC (IP control)
7. Troubleshooting
8. Specifications, etc.

You can select an OSD language from among 7 languages.

English >>
 Deutsch >>
 Français >>
 Italiano >>
 Español >>
 Русский >>
 Polski >>

Ver. 1.15



Menu Operation

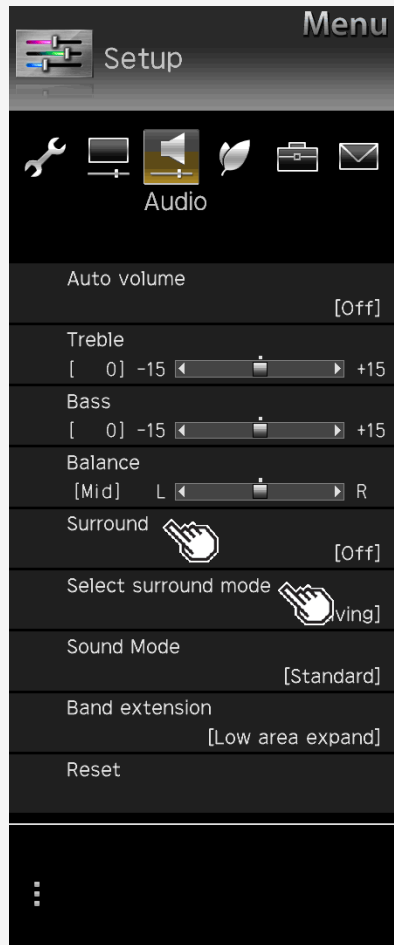

List of Setup Menu Items

Surround

- It realizes quasi-space surrounding Monitor, which is filled with realistic sensation, with in-built speakers.

Setup

Auto, On, Off

Select surround mode

- Select the mode when surround setting is enabled.

Setup

Living

Enjoy three dimensional sound.

Theater

Enjoy realistic sound like a theater.

3D Hall

Enjoy sound surrounding like a hall.

Contents

1. Part Names
2. Basic Operation
3. Menu Operation
4. USB Media
5. AQUOS LINK and Other Devices
6. Operating the Monitor Using a PC (IP control)
7. Troubleshooting
8. Specifications, etc.

You can select an OSD language from among 7 languages.

English >>
Deutsch >>
Français >>
Italiano >>
Español >>
Русский >>
Polski >>

Ver. 1.15



Menu Operation

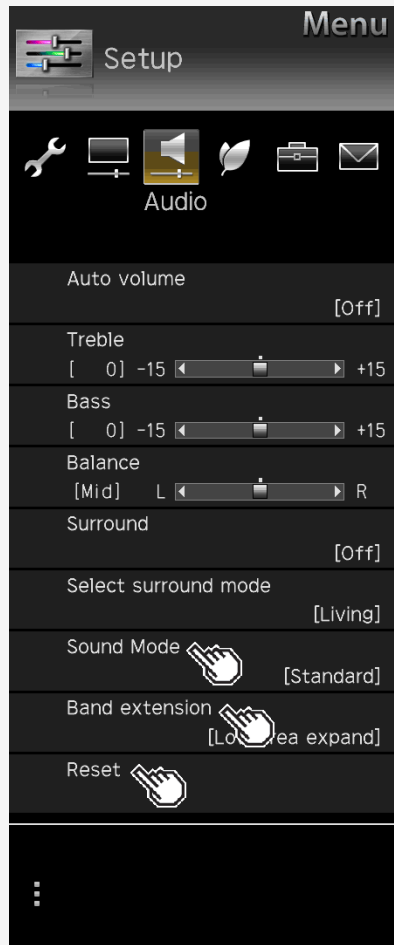

List of Setup Menu Items

Sound Mode

- This function enables you to set the sound quality of the picture mode selected.

Setup	
Standard	Standard setting.
Dynamic	Dynamic sound setting.

Band extension

- Expands band area.

Setup	
Low + high area, Low area expand, No	

Reset

- Resets the audio adjustment settings to factory defaults

Setup	
Yes, No	

Contents

1. Part Names
2. Basic Operation
3. Menu Operation
4. USB Media
5. AQUOS LINK and Other Devices
6. Operating the Monitor Using a PC (IP control)
7. Troubleshooting
8. Specifications, etc.

You can select an OSD language from among 7 languages.

English >>

Deutsch >>

Français >>

Italiano >>

Español >>

Русский >>

Polski >>

Ver. 1.15



Menu Operation

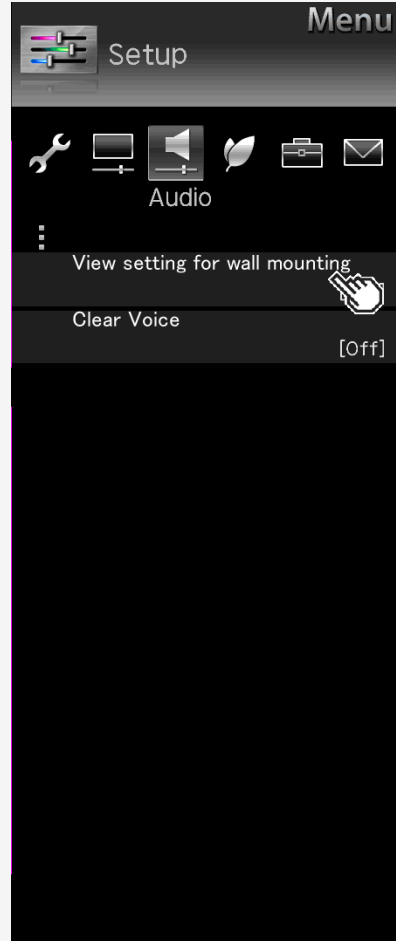

List of Setup Menu Items

View setting for wall mounting

- This function is intended to set the sound quality suitable for the wall mount.

Menu item name	Setup
View setting for wall mounting	Yes, No

NOTE

- **View setting for wall mounting** is intended to set the sound of Monitor typically mounted on wall; however, this setting may not be applicable depending on the wall material quality or the setting conditions. In such a case, from the Menu, adjust "**Setup**" - "**Audio**".
- If **Clear voice** is set to "**Standard**", "**Mild**" or "**Clear**", the view setting is not selectable.
- This function works only for the audio sounds output from the Monitor's speakers. It does not work for any audio sounds from headphones or external speakers.

Contents

1. Part Names
2. Basic Operation
3. Menu Operation
4. USB Media
5. AQUOS LINK and Other Devices
6. Operating the Monitor Using a PC (IP control)
7. Troubleshooting
8. Specifications, etc.

You can select an OSD language from among 7 languages.

English >>

Deutsch >>

Français >>

Italiano >>

Español >>

Русский >>

Polski >>

Ver. 1.15



Menu Operation

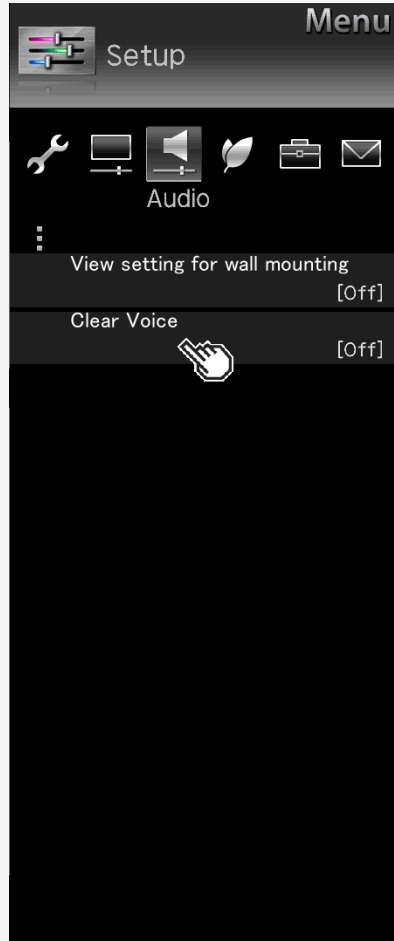

List of Setup Menu Items

Clear voice

- When it is difficult to hear the dialogue of a drama or a movie, this setting makes it easier to hear and understand by emphasizing the human voice range.

Setup	
Standard	This audio setting sets the audio volume to that of the standard sound quality.
Mild	It makes sound quality milder than the standard. Making it easier to listen to dialogue by decreasing sounds effect and noise other than the lines.
Clear	It makes sound quality clearer than the Standard. Making it easier to hear and understand by clearing the speech quality of the spoken dialogue.
Off	This function is disabled. (factory default)

NOTE

- This function works only for the audio sounds output from the Monitor's speakers. It does not work for any audio sounds from headphones or external speakers.

Contents

1. Part Names
2. Basic Operation
3. Menu Operation
4. USB Media
5. AQUOS LINK and Other Devices
6. Operating the Monitor Using a PC (IP control)
7. Troubleshooting
8. Specifications, etc.

You can select an OSD language from among 7 languages.

English >>
Deutsch >>
Français >>
Italiano >>
Español >>
Русский >>
Polski >>

Ver. 1.15



Menu Operation

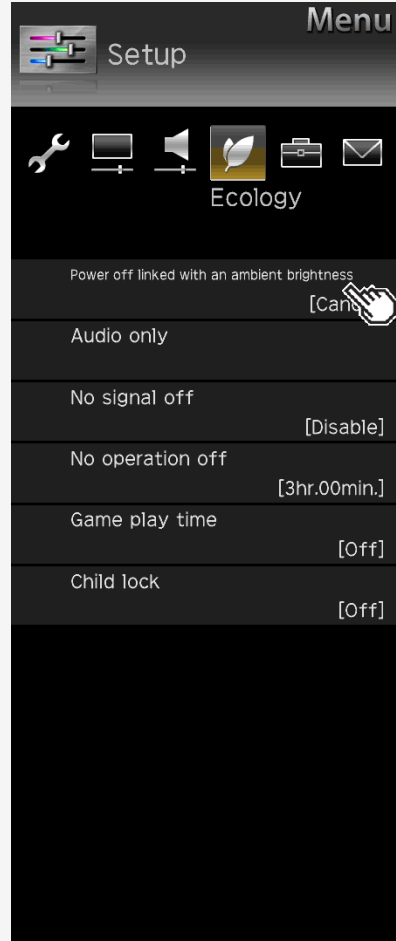

List of Setup Menu Items

Power off linked with an ambient brightness

- When the lighted environment surrounding Monitor gets dark, such as when the room light turns off, Monitor is automatically turned off.

Menu item name	Setup	
Power off linked with an ambient brightness	Cancel, Set	Set "Cancel" "Set" of the Light reliant power off function.
Power off transition time	0min., 15min., 30min., 60min.	This is set so that Monitor is turned "off" in some minutes after the lightness of the room reaches a certain level of darkness and then the screen brightness / volume are turned down.
Icon Setting	Icon and words, Words only	Select whether to display an icon / message, or a message only, on the screen.

NOTE

- If you put an object in front of the brightness sensor, the lightness of the room cannot be detected.

Contents

1. Part Names
2. Basic Operation
3. Menu Operation
4. USB Media
5. AQUOS LINK and Other Devices
6. Operating the Monitor Using a PC (IP control)
7. Troubleshooting
8. Specifications, etc.

You can select an OSD language from among 7 languages.

English >>
Deutsch >>
Français >>
Italiano >>
Español >>
Русский >>
Polski >>

Ver. 1.15



Menu Operation

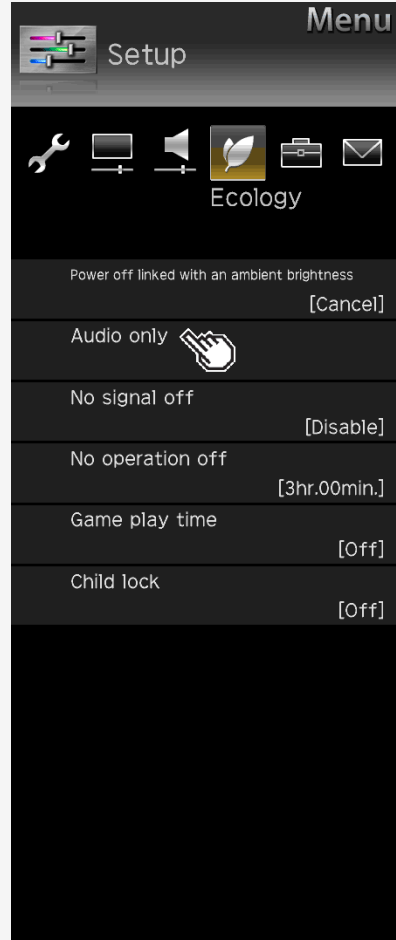

List of Setup Menu Items

Audio only

- You can hear only audio sound with no video playing.

Setup

On, Off

NOTE

- It is automatically set to "Off" if you operate to restore video or turn the power off once.
- To restore video
- Perform operations other than "Volume adjustment", "Mute" or "Audio change".

Contents

1. Part Names
2. Basic Operation
3. Menu Operation
4. USB Media
5. AQUOS LINK and Other Devices
6. Operating the Monitor Using a PC (IP control)
7. Troubleshooting
8. Specifications, etc.

You can select an OSD language from among 7 languages.

English >>
Deutsch >>
Français >>
Italiano >>
Español >>
Русский >>
Polski >>

Ver. 1.15



Menu Operation

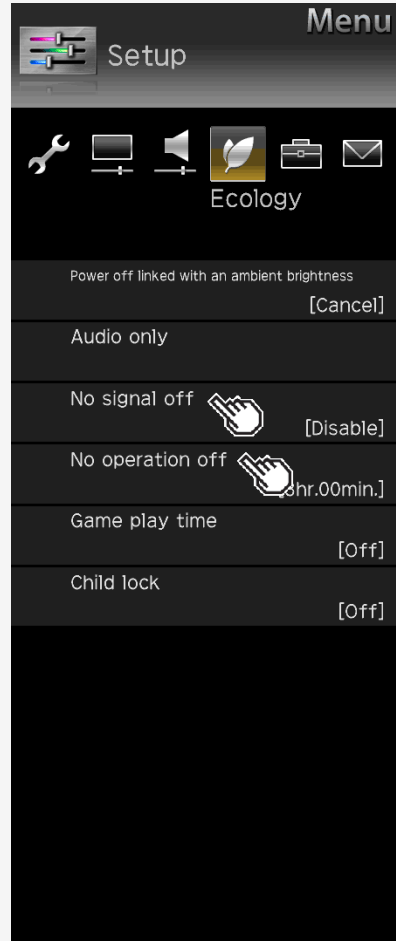

List of Setup Menu Items

No signal off

- Enter standby automatically if no signal is received for 15min.

Setup

Enable, Disable

No operation off

- Enter standby automatically if no operation is occurred for a preset period.

Setup

Disable, 30min, 1hr.00min., 2hr.00min., 3hr.00min.

Contents

1. Part Names
2. Basic Operation
3. Menu Operation
4. USB Media
5. AQUOS LINK and Other Devices
6. Operating the Monitor Using a PC (IP control)
7. Troubleshooting
8. Specifications, etc.

You can select an OSD language from among 7 languages.

English >>
Deutsch >>
Français >>
Italiano >>
Español >>
Русский >>
Polski >>

Ver. 1.15



Menu Operation

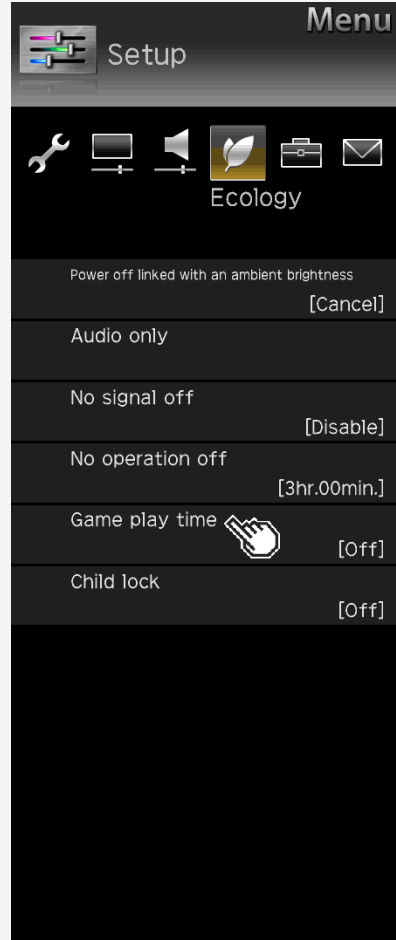

List of Setup Menu Items

Game play time

- It is a function that displays the play time every 30 minutes to prevent her / him from losing track of time playing games
- It is displayed when the input is changed to INPUT1 to INPUT6.

Setup

On, Off

Contents

1. Part Names
2. Basic Operation
3. Menu Operation
4. USB Media
5. AQUOS LINK and Other Devices
6. Operating the Monitor Using a PC (IP control)
7. Troubleshooting
8. Specifications, etc.

You can select an OSD language from among 7 languages.

English >>
Deutsch >>
Français >>
Italiano >>
Español >>
Русский >>
Polski >>

Ver. 1.15



Menu Operation

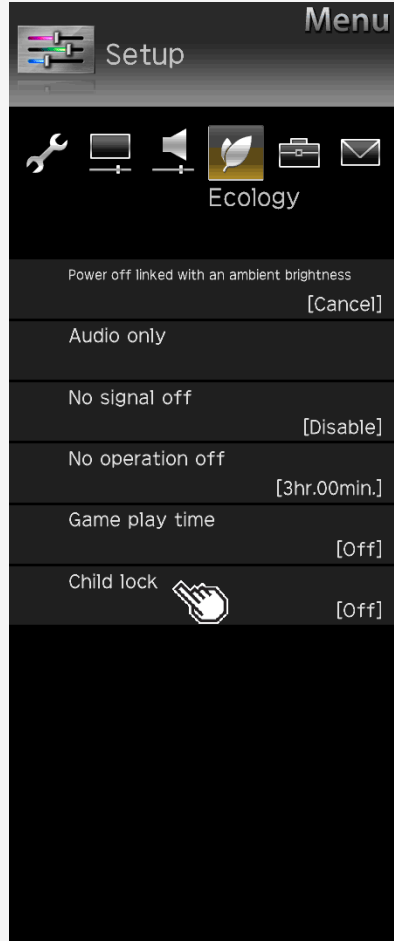

List of Setup Menu Items

Child lock

- You can set to lock the operation of the remote control or Monitor.

Setup

Off, RC control lock, Button control lock

NOTE

- In case you lock the remote control operation by mistake, use Monitor operation button ([1-6](#) page) to unlock.

Contents

1. Part Names
2. Basic Operation
3. Menu Operation
4. USB Media
5. AQUOS LINK and Other Devices
6. Operating the Monitor Using a PC (IP control)
7. Troubleshooting
8. Specifications, etc.

You can select an OSD language from among 7 languages.

English >>
 Deutsch >>
 Français >>
 Italiano >>
 Español >>
 Русский >>
 Polski >>

Ver. 1.15



Menu Operation

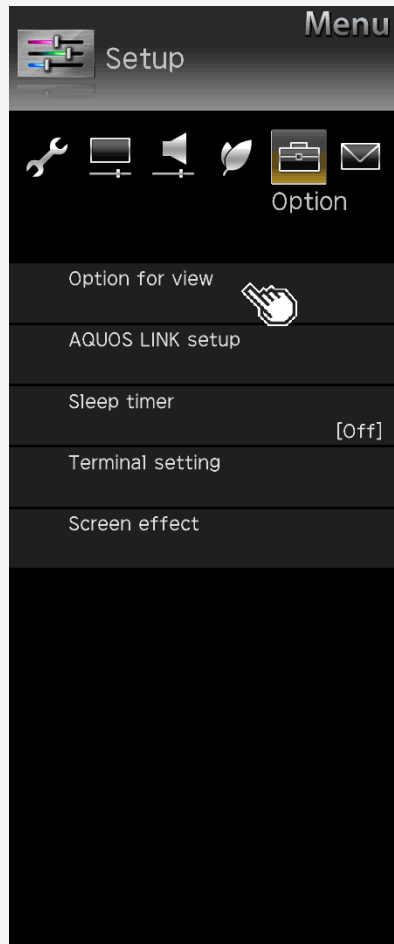

List of Setup Menu Items

Option for view

Menu item name	
Multi-audio	When a program has multiple audio channels, you can switch between the audio channels.

Contents

1. Part Names
2. Basic Operation
3. Menu Operation
4. USB Media
5. AQUOS LINK and Other Devices
6. Operating the Monitor Using a PC (IP control)
7. Troubleshooting
8. Specifications, etc.

You can select an OSD language from among 7 languages.

English >>

Deutsch >>

Français >>

Italiano >>

Español >>

Русский >>

Polski >>

Ver. 1.15



Menu Operation

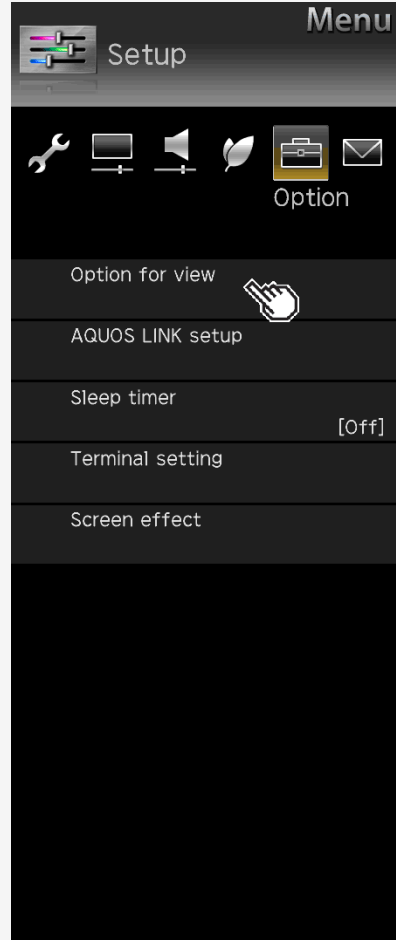

List of Setup Menu Items

Option for view (Continue)

Menu item name	
Wide mode	Depending on the type of content, the black borders around the monitor can be removed by changing the horizontal or vertical width in the " Wide Mode " setting. This operation can also be performed from the Application. (page 3-44) (For information on changing the screen size, see page 5-29 .)

About "Screen size"

- While displaying images from USB memory, the screen size cannot be changed.

Contents

1. Part Names
2. Basic Operation
3. Menu Operation
4. USB Media
5. AQUOS LINK and Other Devices
6. Operating the Monitor Using a PC (IP control)
7. Troubleshooting
8. Specifications, etc.

You can select an OSD language from among 7 languages.

English >>

Deutsch >>

Français >>

Italiano >>

Español >>

Русский >>

Polski >>

Ver. 1.15



Menu Operation

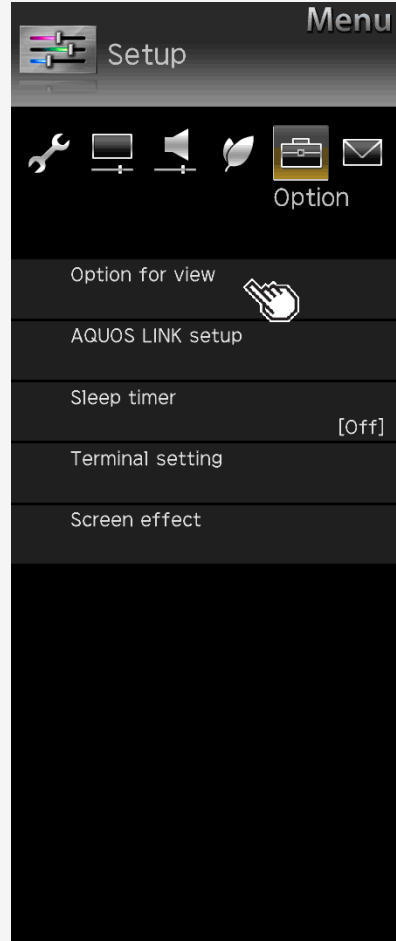

List of Setup Menu Items

Option for view* (Continue)

Menu item name	
AQUOS LINK control	Enables operation of an AQUOS LINK device.
Manual	Displays the built-in Operation Manual.

NOTE

*This is not selectable while the manual is displayed. Exit the manual before selecting this.

Contents

1. Part Names
2. Basic Operation
3. Menu Operation
4. USB Media
5. AQUOS LINK and Other Devices
6. Operating the Monitor Using a PC (IP control)
7. Troubleshooting
8. Specifications, etc.

You can select an OSD language from among 7 languages.

English >>
Deutsch >>
Français >>
Italiano >>
Español >>
Русский >>
Polski >>

Ver. 1.15



Menu Operation

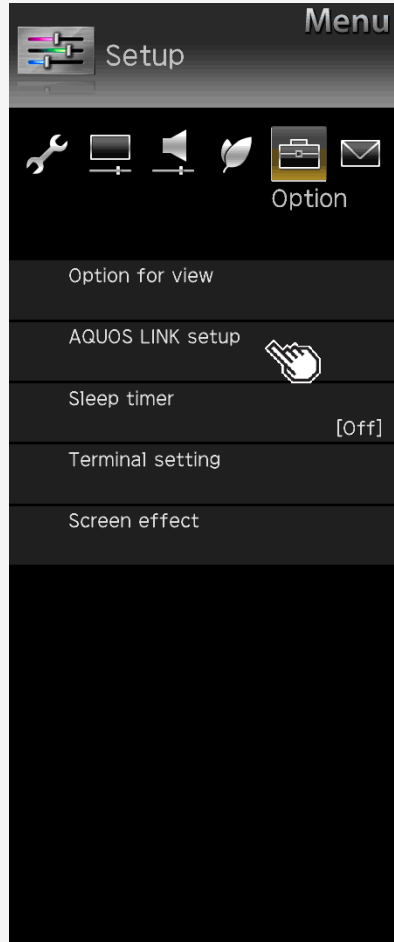

List of Setup Menu Items

AQUOS LINK setup

Menu item name	Setup	
AQUOS LINK control	On, Off	Set it to "Off" if the power supply is turned on or the channel changes automatically when connecting a device that is not AQUOS LINK-enabled.
Auto power on	Yes, No	Set it to turn on automatically once an AQUOS LINK-enabled device is operated.
Select AQUOS LINK device	Select an AQUOS LINK device.	
Selecting channel key	INPUT1	Auto, On, Off
	INPUT2	Auto, On, Off
	INPUT3	Auto, On, Off
	INPUT4	Auto, On, Off
Audio return channel	Auto, Off	"ARC (Audio Return Channel)" is the function to transmit sound from the monitor to the AV amplifier, etc. using an HDMI cable. If you set "Audio return channel" to "Auto", you can connect to an ARC compatible audio device with a HDMI cable. This function is available only when it is connected to INPUT 2 terminal.

You can also setup from the Application menu (page [3-44](#))

Contents

1. Part Names
2. Basic Operation
3. Menu Operation
4. USB Media
5. AQUOS LINK and Other Devices
6. Operating the Monitor Using a PC (IP control)
7. Troubleshooting
8. Specifications, etc.

You can select an OSD language from among 7 languages.

English >>

Deutsch >>

Français >>

Italiano >>

Español >>

Русский >>

Polski >>

Ver. 1.15



Menu Operation

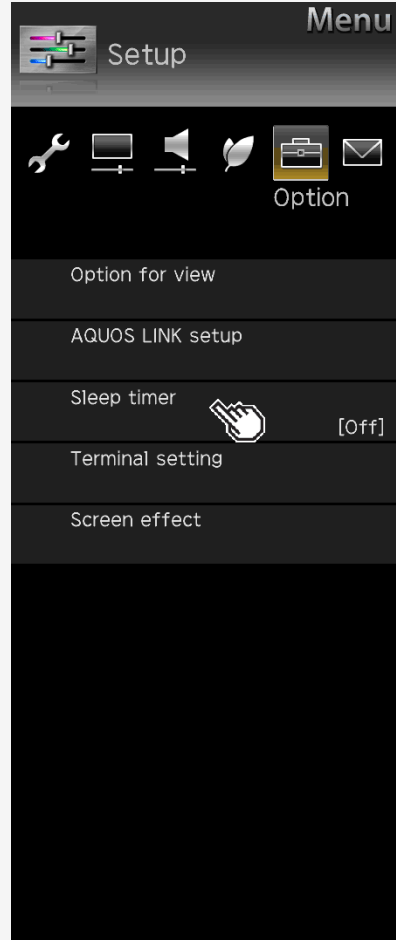

List of Setup Menu Items

Sleep timer

- Turn the power off after the specified time has elapsed (page [2-4](#))

Setup	
Change	Off, 0hr.30min., 1hr.00min., 1hr.30min., 2hr.00min., 2hr.30min.
No	

Contents

1. Part Names
2. Basic Operation
3. Menu Operation
4. USB Media
5. AQUOS LINK and Other Devices
6. Operating the Monitor Using a PC (IP control)
7. Troubleshooting
8. Specifications, etc.

You can select an OSD language from among 7 languages.

English >>
Deutsch >>
Français >>
Italiano >>
Español >>
Русский >>
Polski >>

Ver. 1.15



Menu Operation

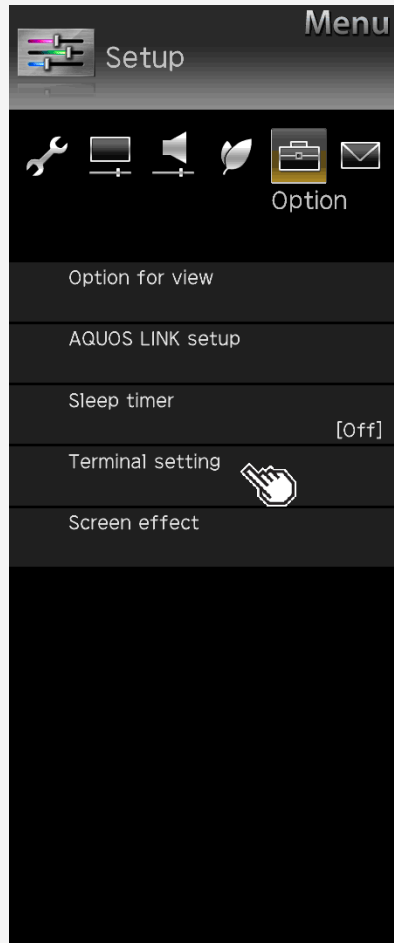

List of Setup Menu Items

Terminal setting

Headphone

- Switches the audio sound between speakers and headphones during the use of the headphones.

Menu item name	Setup	
Headphone	Mode1	This is intended to listen to the Monitor with the headphones alone. Once you connect the headphones, no sound will come out of the speakers.
	Mode2	Sound comes out of the speakers even after the headphones are connected. This is useful for two people with different needs (one having difficulty listening to the Monitor with the speakers alone and the other not wanting the volume of the speakers to be too loud) to enjoy watching the Monitor together.

NOTE

About volume adjustment during "Mode2"

- The speaker volume is adjusted by using the remote control.
- The headphone volume is adjusted by using the volume (+ / -) button on Monitor.
- Even if the **MUTE** button on the remote control is pressed, the volume of the headphones would not become "0".

Contents

1. Part Names
2. Basic Operation
3. Menu Operation
4. USB Media
5. AQUOS LINK and Other Devices
6. Operating the Monitor Using a PC (IP control)
7. Troubleshooting
8. Specifications, etc.

You can select an OSD language from among 7 languages.

English >>
 Deutsch >>
 Français >>
 Italiano >>
 Español >>
 Русский >>
 Polski >>

Ver. 1.15



Menu Operation

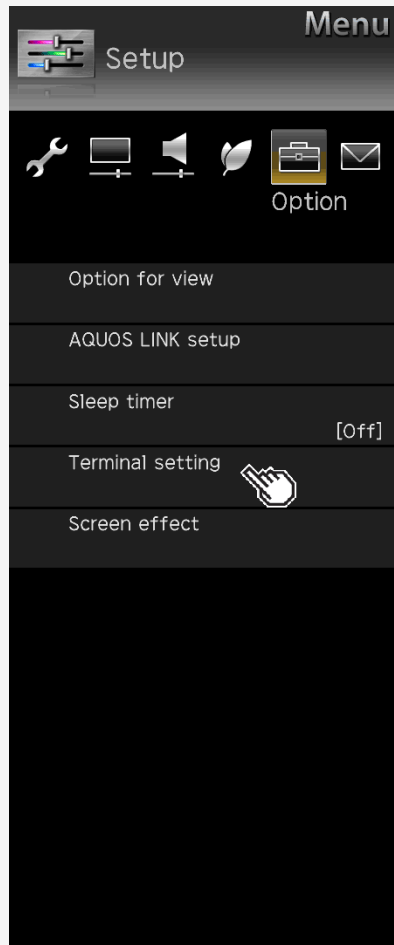

List of Setup Menu Items

Terminal setting (Continue)

Analogue Audio output setting

- Changes the analog audio output setting.

INPUT1 audio select^{*1}

- Switches the audio input terminal for INPUT 1.

INPUT6 audio select^{*2}

- Sets the audio input for INPUT 6.

Menu item name	Setup		
Analogue Audio output setting	Mode1	On, Off	Set to the audio output (fixed). Sounds also come out of the speakers.
	Mode2	On, Off	Set to the audio output (variable). Normally, no sounds come out of the speakers.
	Mode3	On, Off	Set to the audio output (variable). Sounds also come out of the speakers.
INPUT1 audio select	HDMI		Switches the audio input terminal for INPUT 1.
	Analogue audio input		
INPUT6 audio select	Analogue audio input		Sets the audio input for INPUT 6.
	No		

NOTE

*1 It is displayed when the input is changed to INPUT1.

*2 It is displayed when the input is changed to INPUT6.

Contents

1. Part Names
2. Basic Operation
3. Menu Operation
4. USB Media
5. AQUOS LINK and Other Devices
6. Operating the Monitor Using a PC (IP control)
7. Troubleshooting
8. Specifications, etc.

You can select an OSD language from among 7 languages.

English >>
 Deutsch >>
 Français >>
 Italiano >>
 Español >>
 Русский >>
 Polski >>

Ver. 1.15



Menu Operation

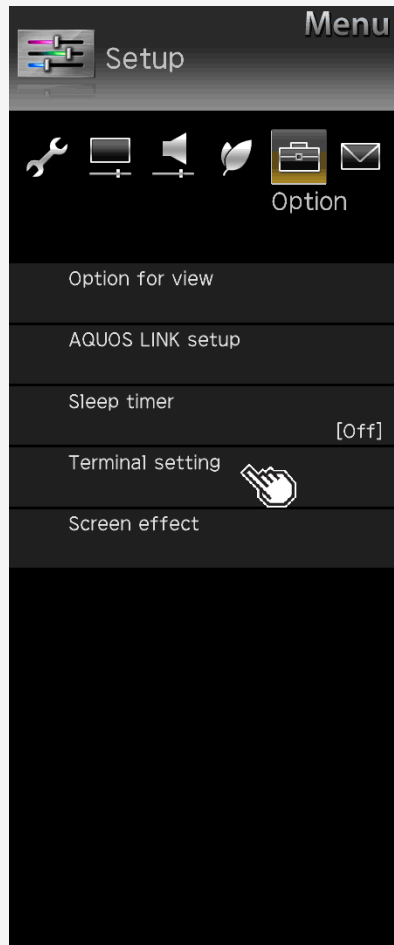

List of Setup Menu Items

Terminal setting (Continue)

Selection of audio sound for INPUT7^{*1}

- Sets the audio input for INPUT7.

Menu item name	Setup	
INPUT7 audio select	INPUT7-A	Uses the INPUT7-A sound.
	INPUT7-B	Uses the INPUT7-B sound.
	INPUT7-C	Uses the INPUT7-C sound.
	INPUT7-D	Uses the INPUT7-D sound.
	Audio input terminal	Uses the Audio input terminal sound.

Digital audio output^{*2}

- Sets the signal format for digital sound

Menu item name	Setup	
Digital audio output	PCM	When connecting a device that is not AAC- / Dolby Digital-compatible, set it to "PCM" (page 5-18). The same sound (Main, sub, M/S) as the program which is being viewed will be the output.
	Bit Stream	To connect an AAC- / Dolby Digital-compatible amplifier, set it to "Bit Stream". Both the main and sub sound will be simultaneously output.

NOTE

*1 For any INPUT other than INPUT7, it is not displayed.

*2 It is displayed when the input is changed to INPUT1,2,3,4.

Contents

1. Part Names
2. Basic Operation
3. Menu Operation
4. USB Media
5. AQUOS LINK and Other Devices
6. Operating the Monitor Using a PC (IP control)
7. Troubleshooting
8. Specifications, etc.

You can select an OSD language from among 7 languages.

English >>
 Deutsch >>
 Français >>
 Italiano >>
 Español >>
 Русский >>
 Polski >>

Ver. 1.15



Menu Operation

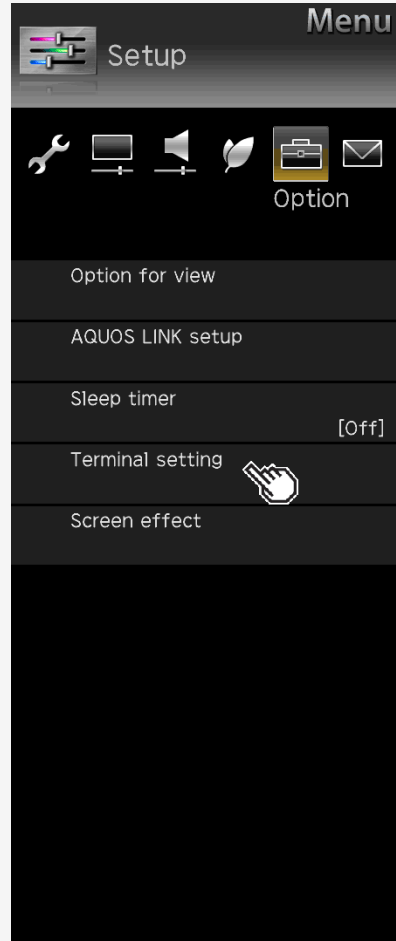

List of Setup Menu Items

Terminal setting (Continue)

Input skip

- Unused inputs (INPUT1 to 4, INPUT6, INPUT7) can be skipped during input change.

Menu item name	Setup	
Input skip	INPUT1 (HDMI)	Yes, No
	INPUT2 (HDMI)	Yes, No
	INPUT3 (HDMI)	Yes, No
	INPUT4 (HDMI)	Yes, No
	INPUT6 (PC)	Yes, No
	INPUT7 (8K)	Yes, No

Contents

1. Part Names
2. Basic Operation
3. Menu Operation
4. USB Media
5. AQUOS LINK and Other Devices
6. Operating the Monitor Using a PC (IP control)
7. Troubleshooting
8. Specifications, etc.

You can select an OSD language from among 7 languages.

English >>
Deutsch >>
Français >>
Italiano >>
Español >>
Русский >>
Polski >>

Ver. 1.15



Menu Operation

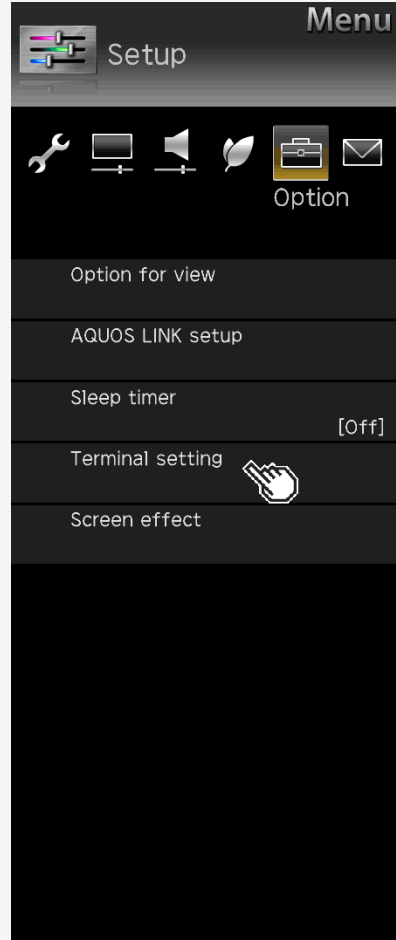

List of Setup Menu Items

Terminal setting (Continue)

Input label

- The device names displayed in the input menu, etc. can be changed to the names of the devices connected to INPUT 1 to 7.

Menu item name	Setup
Input label ^{*1}	(Entry depends on selection) User Setting: EDIT

NOTE

*1 It is displayed when the input is changed to INPUT1 to INPUT7.

Contents

1. Part Names
2. Basic Operation
3. Menu Operation
4. USB Media
5. AQUOS LINK and Other Devices
6. Operating the Monitor Using a PC (IP control)
7. Troubleshooting
8. Specifications, etc.

You can select an OSD language from among 7 languages.

English >>
 Deutsch >>
 Français >>
 Italiano >>
 Español >>
 Русский >>
 Polski >>

Ver. 1.15



Menu Operation

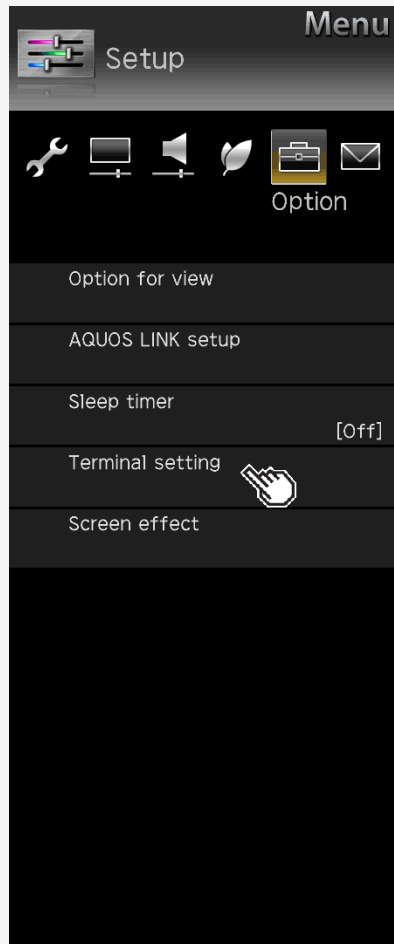

List of Setup Menu Items

Terminal setting (Continue)

Suitable mode for signals

- Changes the suitable mode for signals in order to maintain compatibility with connected devices. (INPUT 1 only)

Menu item name	Setup	
Suitable mode for signals	Full mode (HDR)	The mode is intended for connected devices that provide support for the high definition (4:4:4/4:2:2) / wide color gamut (BT.2020) / high contrast (HDR) of 4K video.
	Full mode	The mode is intended for connected devices that provide support for the high definition (4:4:4/4:2:2) / wide color gamut (BT.2020) of 4K video.
	Compatibility mode 1	The mode is intended for connected devices that provide support for the high definition (4:4:4/4:2:2) of 4K video.
	Compatibility mode 2	The mode is intended to place high priority on compatibility with connected devices.

Contents

1. Part Names
2. Basic Operation
3. Menu Operation
4. USB Media
5. AQUOS LINK and Other Devices
6. Operating the Monitor Using a PC (IP control)
7. Troubleshooting
8. Specifications, etc.

You can select an OSD language from among 7 languages.

English >>
Deutsch >>
Français >>
Italiano >>
Español >>
Русский >>
Polski >>

Ver. 1.15



Menu Operation

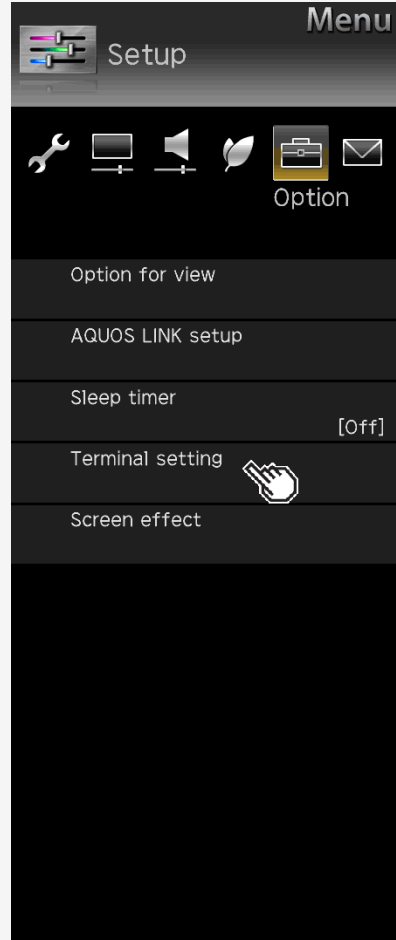

List of Setup Menu Items

Terminal setting (Continue)

4K signal for each mode

Setup	Supported frame rate	Supported chroma sampling	BT.2020 color gamut support	HDR support
Full mode (HDR)	24p/25p/30p/50p/60p	4:2:0/4:2:2/4:4:4	o	o
Full mode	24p/25p/30p/50p/60p	4:2:0/4:2:2/4:4:4	o	—
Compatibility mode 1	24p/25p/30p/50p/60p	4:2:0/4:2:2/4:4:4	—	—
Compatibility mode 2	24p/25p/30p/50p/60p	4:2:0	—	—

*If a video or audio sound is not properly output in "Full mode(HDR)" or "Full mode", set it to "Compatibility mode 1" or "Compatibility mode 2".

4K video signal for INPUT2 to 4

Supported frame rate	Supported chroma sampling	BT.2020 color gamut input support
24p/25p/30p/50p/60p	4:2:0	—

NOTE

- It is displayed when the input is changed to INPUT1.
- During "Full mode (HDR)", "OPC" (page [3-9](#)) and "Backlight" (page [3-10](#)) can be adjusted independently for HDR and SDR video contents.

Contents

1. Part Names
2. Basic Operation
3. Menu Operation
4. USB Media
5. AQUOS LINK and Other Devices
6. Operating the Monitor Using a PC (IP control)
7. Troubleshooting
8. Specifications, etc.

You can select an OSD language from among 7 languages.

English >>

Deutsch >>

Français >>

Italiano >>

Español >>

Русский >>

Polski >>

Ver. 1.15



Menu Operation

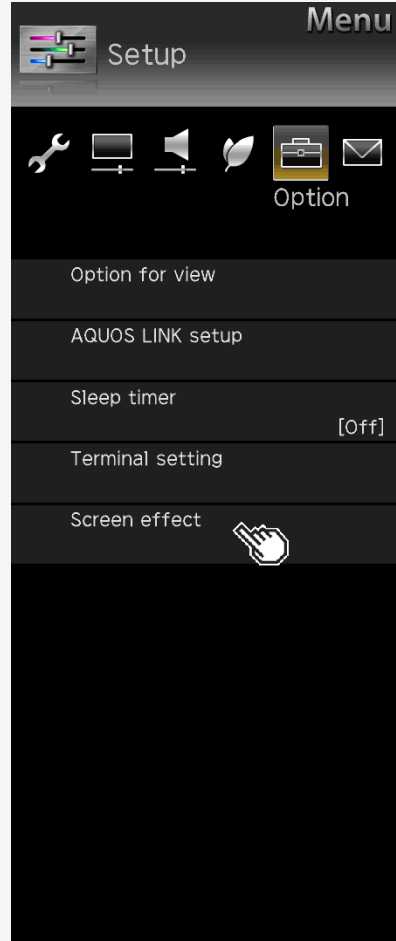

List of Setup Menu Items

Screen effect

Menu item name		Setup
Position	H-Pos.	Adjusts the position of a left-aligned or right-aligned image using button.
	V-Pos.	Adjusts the position of an image positioned too high or low using button.
	Reset	Resets to factory default.

Contents

1. Part Names
2. Basic Operation
3. Menu Operation
4. USB Media
5. AQUOS LINK and Other Devices
6. Operating the Monitor Using a PC (IP control)
7. Troubleshooting
8. Specifications, etc.

You can select an OSD language from among 7 languages.

English >>

Deutsch >>

Français >>

Italiano >>

Español >>

Русский >>

Polski >>

Ver. 1.15



Menu Operation

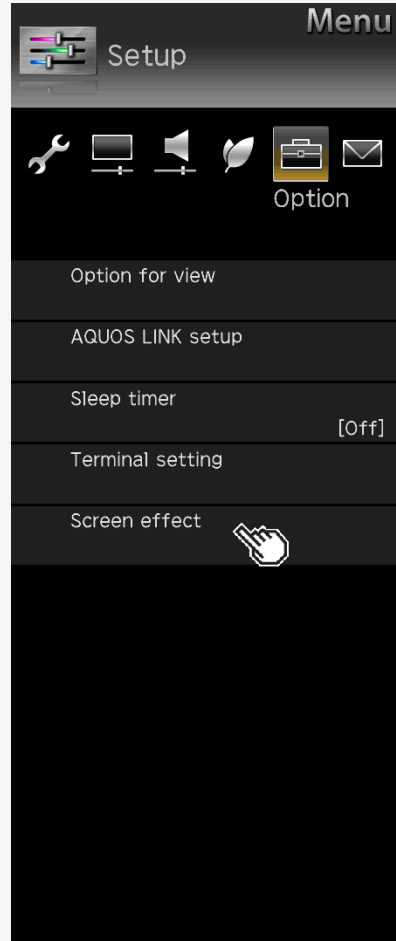

List of Setup Menu Items

Screen effect (Continue)

Auto Wide

- According to the type of original video, you can display the video on the screen of the size most suitable for the video.

Menu item name		Setup	
Auto Wide	Auto Mode	Yes, No	In the presence of black curtains / bars at the top and bottom of the video (screen) input from INPUT1 to 5, the screen size will be automatically switched to "Zoom".
	HDMI Signal	Enable, Disable	If any screen size control signal is included in a video input from INPUT1 to 4, the screen size will be automatically optimized.

Contents

1. Part Names
2. Basic Operation
3. Menu Operation
4. USB Media
5. AQUOS LINK and Other Devices
6. Operating the Monitor Using a PC (IP control)
7. Troubleshooting
8. Specifications, etc.

You can select an OSD language from among 7 languages.

English >>
 Deutsch >>
 Français >>
 Italiano >>
 Español >>
 Русский >>
 Polski >>

Ver. 1.15



Menu Operation

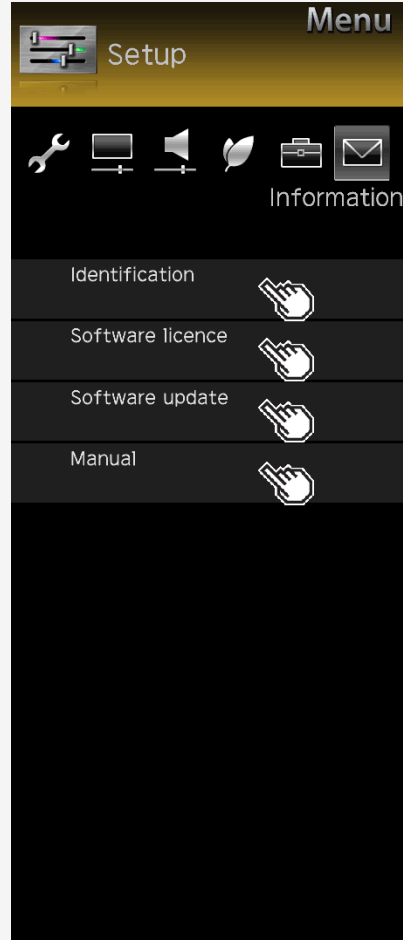

List of Setup Menu Items

Identification

- Displays the system status

Setup

Start, Test pattern

Software license

- Displays software licenses

Software update

- Updates software.

Setup

USB update

Manual

- Displays E-Manual (operation guide).

Contents

1. Part Names
2. Basic Operation
3. Menu Operation
4. USB Media
5. AQUOS LINK and Other Devices
6. Operating the Monitor Using a PC (IP control)
7. Troubleshooting
8. Specifications, etc.

You can select an OSD language from among 7 languages.

English >>
Deutsch >>
Français >>
Italiano >>
Español >>
Русский >>
Polski >>

Ver. 1.15

Menu Operation



How to Use Application Menu

Basic procedure for using the Application

1. Press **APPS** to display the Application.
 - You can also use the Application menu by selecting "**Application**" of the Menu item.
2. Press **▲/▼** to select a desired item, and then press **ENTER**
 - You can also select an item by using a channel (number) button on the remote control.
3. Press **▲/▼** to select another desired item, and then press **ENTER**
 - Depending on the item selected, you may have to make further item selections.

NOTE

- The items in the Application menu vary depending on the currently-displayed screen

Contents

1. Part Names
2. Basic Operation
3. Menu Operation
4. USB Media
5. AQUOS LINK and Other Devices
6. Operating the Monitor Using a PC (IP control)
7. Troubleshooting
8. Specifications, etc.

You can select an OSD language from among 7 languages.

- English >>
- Deutsch >>
- Français >>
- Italiano >>
- Español >>
- Русский >>
- Polski >>

Ver. 1.15

Menu Operation



Entering Letters (Software Keyboard)

- If you are required to enter letters, use on-screen software keyboard for entry.
- The software keyboard will be displayed if you select an entry field and press **ENTER**.

Software keyboard screen example ¹

(Screen showing predictive conversion candidates, character types, etc. is for illustrative purposes only.)

You can select any letter or function with the ▲/▼/◀/▶ and ENTER buttons. The functions with button name, such as "character type change" or "complete" can be directly selected with the buttons on the remote control.

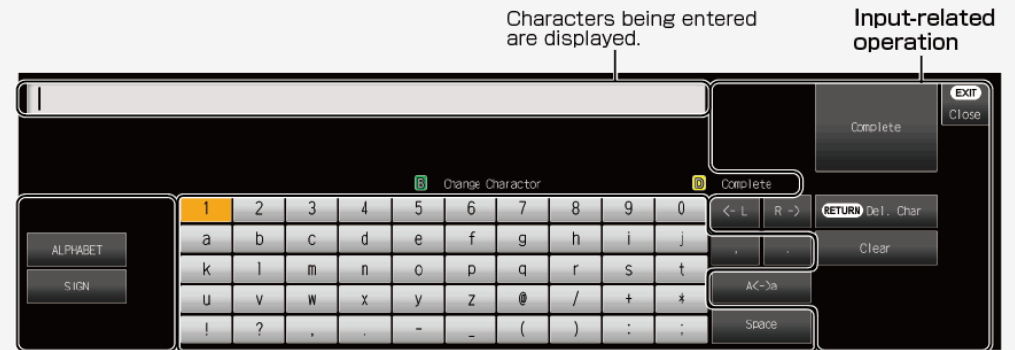

Character type

Selectable characters depend on the entry field.

Characters that can be entered

The characters that can be entered vary depending on the character type or the entry field.

Contents

1. Part Names
2. Basic Operation
3. Menu Operation
4. USB Media
5. AQUOS LINK and Other Devices
6. Operating the Monitor Using a PC (IP control)
7. Troubleshooting
8. Specifications, etc.

You can select an OSD language from among 7 languages.

English >>

Deutsch >>

Français >>

Italiano >>

Español >>

Русский >>

Polski >>

Ver. 1.15



USB Media

Before Using USB Media

What you can do with USB Media

- You can play the photo, music or video files stored on USB memory. In addition, you can copy photos to a USB memory .

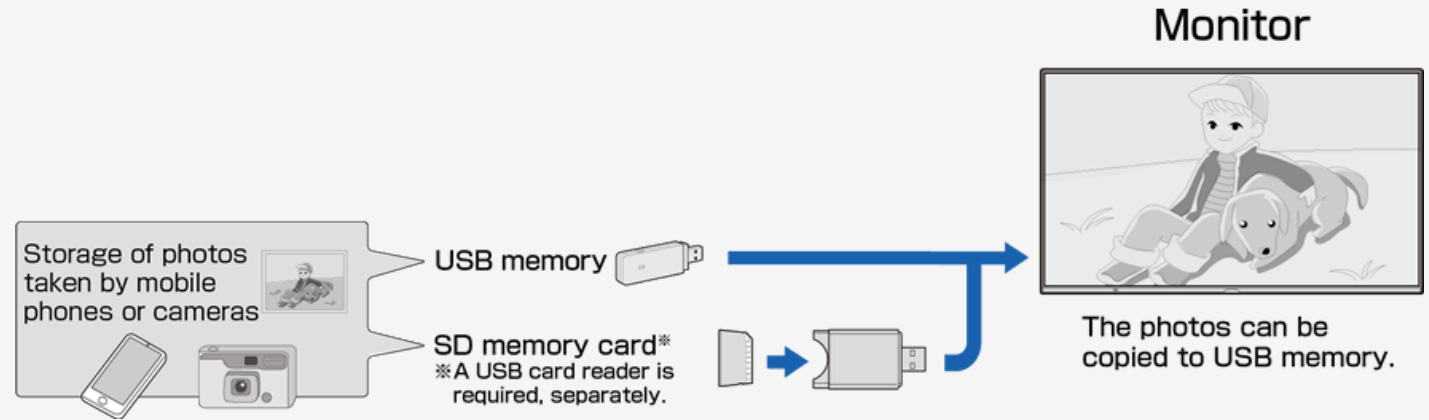

Contents

1. Part Names
2. Basic Operation
3. Menu Operation
4. USB Media
5. AQUOS LINK and Other Devices
6. Operating the Monitor Using a PC (IP control)
7. Troubleshooting
8. Specifications, etc.

You can select an OSD language from among 7 languages.

English >>

Deutsch >>

Français >>

Italiano >>

Español >>

Русский >>

Polski >>

Ver. 1.15



USB Media

Before Using USB Media

About USB memories that can be attached to Monitor

Devices that can be connected to USB terminal

- USB memory, USB card reader (mass storage class)

File system

- FAT, FAT32

NOTE

- If you attach a USB memory to Monitor with the power on, the USB Media will be displayed.

Contents

1. Part Names
2. Basic Operation
3. Menu Operation
4. USB Media
5. AQUOS LINK and Other Devices
6. Operating the Monitor Using a PC (IP control)
7. Troubleshooting
8. Specifications, etc.

You can select an OSD language from among 7 languages.

English >>

Deutsch >>

Français >>

Italiano >>

Español >>

Русский >>

Polski >>

Ver. 1.15



USB Media

Before Using USB Media

About USB memories attached to Monitor

How to attach / remove USB memory

- Do not remove the USB memory from Monitor while transferring files, viewing slide shows, switching screens or before exiting "**USB Media**" at the input selection menu.
- Do not insert and remove a USB memory repeatedly without any reason.
- When using a USB card reader, make sure to insert a memory card in the USB card reader before connecting it to the Monitor.
- Do not use any USB extension cable to connect USB memory into the USB terminal on the Monitor. The Monitor may fail to operate properly if you do so.
- Turn off the Monitor before removing the USB memory.

Contents

1. Part Names
2. Basic Operation
3. Menu Operation
4. USB Media
5. AQUOS LINK and Other Devices
6. Operating the Monitor Using a PC (IP control)
7. Troubleshooting
8. Specifications, etc.

You can select an OSD language from among 7 languages.

English >>

Deutsch >>

Français >>

Italiano >>

Español >>

Русский >>

Polski >>

Ver. 1.15



USB Media

Before Using USB Media

About files in USB memory that can be played on Monitor

Photo file format

- JPEG (jpg) (DCF2.0-compliant)
- Maximum resolution (image size): 16384 x 16384 pixels
- Minimum resolution (image size): 32 x 32 pixels
- If a JPEG still image file is large in size, the file may be required time to display the photo.

Contents

1. Part Names
2. Basic Operation
3. Menu Operation
4. USB Media
5. AQUOS LINK and Other Devices
6. Operating the Monitor Using a PC (IP control)
7. Troubleshooting
8. Specifications, etc.

You can select an OSD language from among 7 languages.

English >>

Deutsch >>

Français >>

Italiano >>

Español >>

Русский >>

Polski >>

Ver. 1.15



USB Media

Before Using USB Media

About files in USB memory that can be played on Monitor

Music file format

- FLAC (.fla)
Bit rate: 128k to 2304kbps
Sampling frequency: 8k, 16k, 22.05k, 24k, 32k, 44.1k, 48k, 88.2k, 96k, 192kHz
Quantization bit rate: 8bit, 16bit, 24bit
- MP3 (.mp3)
Bit rate: 32 to 320kbps
Sampling frequency: 32k, 44.1k, 48kHz
- WAV (.wav)
Bit rate: 64 to 1536kbps (LPCM)
Sampling frequency: 32k, 44.1k, 48kHz
- WMA (.wma)
Bit rate: 32 to 384kbps
Sampling frequency: 8k, 11.025k, 16k, 22.05k, 32k, 44.1k, 48kHz
- AAC (.m4a / .aac)
Bit rate: 1 to 1728kbps
Sampling frequency:
8k, 11.025k, 12k, 16k, 22.05k, 24k, 32k, 44.1k, 48kHz (AAC)
16k, 22.05k, 24k, 32k, 44.1k, 48kHz (HE-AAC)

Contents

1. Part Names
2. Basic Operation
3. Menu Operation
4. USB Media
5. AQUOS LINK and Other Devices
6. Operating the Monitor Using a PC (IP control)
7. Troubleshooting
8. Specifications, etc.

You can select an OSD language from among 7 languages.

English >>

Deutsch >>

Français >>

Italiano >>

Español >>

Русский >>

Polski >>

Ver. 1.15



USB Media

Before Using USB Media

About files in USB memory that can be played on Monitor

Video file format

- m2ts, mp4, 3gp

NOTE

- jpeg files in progressive format cannot be supported.
- 3D-form photos cannot be supported.
- Music files in USB1.1 device may not be played properly.
- Depending on a certain type of USB memory devices, the stored data may not be recognized in Monitor.
- The file name may not be displayed if length of the file name exceeds 80 characters.
- Files may not be played properly even if their file format is supported.
- Music files which are subject to copyright protection may not be played properly.

Contents

1. Part Names
2. Basic Operation
3. Menu Operation
4. USB Media
5. AQUOS LINK and Other Devices
6. Operating the Monitor Using a PC (IP control)
7. Troubleshooting
8. Specifications, etc.

You can select an OSD language from among 7 languages.

English >>
Deutsch >>
Français >>
Italiano >>
Español >>
Русский >>
Polski >>

Ver. 1.15

USB Media



Enjoying Photo

Displaying photo

About this function

- You can display photos on USB memory.

NOTE

- It may take more than 20 seconds to display a photo depending on the pixel size.

How to operate

1. Press **INPUT**, use the **▲▼** button to select "**USB media**", and then press **ENTER**
- Once USB memory is connected, "**USB media**" will be automatically displayed.
2. Press **◀▶** to select "**Photo mode**", and then press **ENTER**

Contents

1. Part Names
2. Basic Operation
3. Menu Operation
4. USB Media
5. AQUOS LINK and Other Devices
6. Operating the Monitor Using a PC (IP control)
7. Troubleshooting
8. Specifications, etc.

You can select an OSD language from among 7 languages.

English >>
Deutsch >>
Français >>
Italiano >>
Español >>
Русский >>
Polski >>

Ver. 1.15



USB Media



Enjoying Photo

Displaying photo

4. Press to select a folder, and then press **ENTER**
 5. Press / to select photo, and then press **ENTER**
- The photo appears full-screen.
 - If you select a folder, all images in the folder will be displayed.
 - By pressing **RETURN**, you can return to photo select screen.

NOTE

- If there is an invalid photo file, X mark is played on the thumbnail.
- At the bottom left corner of the photo select screen, file name, photo data*, pixel / file size, and remaining capacity of the media are displayed.
- Only EXIF file format data can be shown.
- Depending on a certain photo data, they may not be displayed as thumbnail.
- When any photo is not shown but an error message appears, see "Error Message about USB Media" (pages [7-9](#) to [7-11](#)).

Contents

1. Part Names
2. Basic Operation
3. Menu Operation
4. USB Media
5. AQUOS LINK and Other Devices
6. Operating the Monitor Using a PC (IP control)
7. Troubleshooting
8. Specifications, etc.

You can select an OSD language from among 7 languages.

English >>
Deutsch >>
Français >>
Italiano >>
Español >>
Русский >>
Polski >>

Ver. 1.15

USB Media



Enjoying Photo

Operation during photo display

About this function

- When viewing photos, you can switch to the next photo.
- A guidance (operation guide) indicating the operation method is displayed at the bottom of the screen. Press the buttons according to the guidance display to operate.

NOTE

- Photos cannot be rotated.

Operation while displaying the photo

◀▶: Switch to previous or next photo in the same folder.

C: Toggles between displaying and not displaying the operation guide.

APPS: Displays the function menu.

RETURN: Returns to the display list.

EXIT: Quits the USB Media.

Contents

1. Part Names
2. Basic Operation
3. Menu Operation
4. USB Media
5. AQUOS LINK and Other Devices
6. Operating the Monitor Using a PC (IP control)
7. Troubleshooting
8. Specifications, etc.

You can select an OSD language from among 7 languages.

- English >>
- Deutsch >>
- Français >>
- Italiano >>
- Español >>
- Русский >>
- Polski >>

Ver. 1.15

USB Media



Enjoying Photo

Switching photo display mode

About this function

- You can switch the photo display mode

How to operate

1. During the display of photo, press **APPS**, use the **▲/▼** button to select "**Screen Size**", and then press **ENTER**
2. Use the **▲/▼** button to specify the desired setting, and then press **ENTER**

About display mode switch item and photo display

Image size	Normal	Dot by Dot
Image with a dot size over 7680x4320		Enlarges an image to full screen to display without changing the aspect ratio. For an image with an aspect ratio other than 16:9, black bars appears on the sides or top and bottom of the screen
Image with a dot size up to 7680x4320		Enlarges an image to full screen for display without changing the aspect ratio.
		Display an image according to the screen resolution.

Contents

1. Part Names
2. Basic Operation
3. Menu Operation
4. USB Media
5. AQUOS LINK and Other Devices
6. Operating the Monitor Using a PC (IP control)
7. Troubleshooting
8. Specifications, etc.

You can select an OSD language from among 7 languages.

English >>

Deutsch >>

Français >>

Italiano >>

Español >>

Русский >>

Polski >>

Ver. 1.15



USB Media

Enjoying Photo

Enjoying slide show

About this function

- Photos can be displayed as a slide show.
- The photos from USB memory can be selected to be displayed as slide show.

Contents

1. Part Names
2. Basic Operation
3. Menu Operation
4. USB Media
5. AQUOS LINK and Other Devices
6. Operating the Monitor Using a PC (IP control)
7. Troubleshooting
8. Specifications, etc.

You can select an OSD language from among 7 languages.

English >>
Deutsch >>
Français >>
Italiano >>
Español >>
Русский >>
Polski >>

Ver. 1.15

USB Media



Enjoying Photo

Enjoying slide show

To play a slide show based on photo list

1. Press **INPUT**, followed by **▲▼** to select "**USB media**" and then press **ENTER**
2. If more than one USB memory are connected, select desired memory with **C**
3. Press **◀▶** to select "**Photo Mode**", and then press **ENTER**

Contents

1. Part Names
2. Basic Operation
3. Menu Operation
4. USB Media
5. AQUOS LINK and Other Devices
6. Operating the Monitor Using a PC (IP control)
7. Troubleshooting
8. Specifications, etc.

You can select an OSD language from among 7 languages.

English >>
Deutsch >>
Français >>
Italiano >>
Español >>
Русский >>
Polski >>

Ver. 1.15

USB Media



Enjoying Photo

Enjoying slide show

To play a slide show based on a photo list.

4. Press to select a folder, and then press **ENTER**
5. Press **C**

- Photo selection mode will be used to display photos. Press /// to select the photos to be displayed as a slide show. Press **D** to toggle between selecting / deselecting the photos. To select / deselect photos all at once, press **Apps**, and then choose between "**Set all slide show image**" or "**Reset all slide show image**" from the function menu. Press **C** to start slide show.
- To quit the slide show, press **Return**.

Contents

1. Part Names
2. Basic Operation
3. Menu Operation
4. USB Media
5. AQUOS LINK and Other Devices
6. Operating the Monitor Using a PC (IP control)
7. Troubleshooting
8. Specifications, etc.

You can select an OSD language from among 7 languages.

- English >>
- Deutsch >>
- Français >>
- Italiano >>
- Español >>
- Русский >>
- Polski >>

Ver. 1.15

USB Media

Enjoying Photo

Setting up slide show

About this function

1. Press **APPS** on the photo list screen to display the function menu.
2. Press **▲/▼** to select "**Slide Show Setup**", and then press **ENTER**
3. Press **▲/▼** to select the setting, and then press **ENTER**



Contents

1. Part Names
2. Basic Operation
3. Menu Operation
4. USB Media
5. AQUOS LINK and Other Devices
6. Operating the Monitor Using a PC (IP control)
7. Troubleshooting
8. Specifications, etc.

You can select an OSD language from among 7 languages.

English >>

Deutsch >>

Français >>

Italiano >>

Español >>

Русский >>

Polski >>

Ver. 1.15



USB Media

Enjoying Photo

Setting up slide show

Slide show interval

- Set the time duration before switching to the next picture.
- Depending on the photo, the display may not be switched according to the set time.

Slide show off timer setting

- Set the timer for the slide show. The power will automatically turn off after the set time duration.
- This is a function that can be helpful should you forget to turn off the power supply when using this machine as a large screen photo frame.
- The timer will start only during slide show operation.

Low brightness mode

- Reduces glare so that the slide show can be enjoyed better.
- Even when displaying a slide show for a long duration, the power consumption can be reduced to a certain degree.
(The power consumption reduction depends on the environment and the photos.)

Contents

1. Part Names
2. Basic Operation
3. Menu Operation
4. USB Media
5. AQUOS LINK and Other Devices
6. Operating the Monitor Using a PC (IP control)
7. Troubleshooting
8. Specifications, etc.

You can select an OSD language from among 7 languages.

English >>
Deutsch >>
Français >>
Italiano >>
Español >>
Русский >>
Polski >>

Ver. 1.15

USB Media



Enjoying Photo

Selecting BGM for a slide show

About this function

- Choosing the music (BGM) that will be played when displaying the slide show.
 - The music stored in the USB memory can be used as BGM.
1. Press **B** in the slide show picture selection mode.
 2. Press **▲/▼/◀/▶** to select the media, and then press **ENTER**
 3. Press **◀/▶** to select the folder that contains the audio file to be made as BGM, and then press **ENTER**
 4. Press **▲/▼** to select the audio file that will be made as BGM, and then press **D** to select / deselect it
 5. Press **RETURN** to return to the screen which is displayed for selecting the folder.
 6. Press **RETURN** to return to the slide show photo selection mode.
 7. Press **C** in photo selection mode to start the slide show.

NOTE

- In initial setting, all music files are selected by default.
- During the display of the slide show, the selected BGM will be repeatedly played back.

Contents

1. Part Names
2. Basic Operation
3. Menu Operation
4. USB Media
5. AQUOS LINK and Other Devices
6. Operating the Monitor Using a PC (IP control)
7. Troubleshooting
8. Specifications, etc.

You can select an OSD language from among 7 languages.

English >>
Deutsch >>
Français >>
Italiano >>
Español >>
Русский >>
Polski >>

Ver. 1.15



USB Media



Enjoying Photo

Copying photo

About this function

- Copying a photo from USB memory to another memory.
- When copying a photo to an SD memory card, a USB card reader is needed.
- Attach the USB memory to be used for copying to the Monitor in advance.
- Specify the copy destination by using the Setup menu, and then use USB Media to perform copy operation.

To copy photos, more than one USB memories need to be connected. However, only one connection is allowed when setting the USB memory destination.

Specify the destination to copy the photo

1. Make sure that only one USB memory is attached to the Monitor.
 2. Press **MENU** to display the Menu, press **▲/▼/◀/▶** to select "**Setup**", and then press **ENTER**
 3. Press **▲/▼/◀/▶** to select "(Initial Setup)" - "**Individual setting**" - "**USB memory setting**", and then press **ENTER**
 4. Press **▲/▼** button to select "**Select USB memory**", and then press **ENTER**
 5. Press **◀/▶** button to select "**Yes**", and then press **ENTER**
- For information on copy operation, see page [4-18](#).

Contents

1. Part Names
2. Basic Operation
3. Menu Operation
4. USB Media
5. AQUOS LINK and Other Devices
6. Operating the Monitor Using a PC (IP control)
7. Troubleshooting
8. Specifications, etc.

You can select an OSD language from among 7 languages.

English >>
Deutsch >>
Français >>
Italiano >>
Español >>
Русский >>
Polski >>

Ver. 1.15

USB Media



Enjoying Photo

Copying photo

- To copy photos, more than one USB memories need to be connected. However, only one connection is allowed when setting the USB memory destination.

1. Connect the USB memory destination.
2. If more than one USB memory are connected, select desired memory with **C**.
3. Press **▲**, and then press **◀▶** to select a memory on which the target photo is stored, and then press **ENTER**.
4. Press **◀▶** to select "**Photo Mode**", and then press **ENTER**.
5. Press **◀▶** to select the folder containing the target photo, and then press **ENTER**.
6. Press **APPS** or **A**, followed by **▲▼** to select "**Copy picture**", and then press **ENTER**.
7. Select the copy source from "**All folder**", "**Current folder**" or "**Selected file**", and then press **ENTER**.
8. If you select "**Selected file**", the image selection screen will be displayed. Press **▲▼/◀▶** and **D** to select the file to be copied, and then press **A**.
9. Press **▲▼** to select the destination to save, and then press **ENTER**.
10. Press **▲▼** to select the folder to save the file, and then press **ENTER**.
11. If you select "**Create new folder**", you can create a new folder. A software keyboard appears, which you will use to enter the name of the folder.(page [3-45](#))
12. Use the **▲▼** button to select "**Yes**", and then press **ENTER**.
13. Press **ENTER** on the confirmation screen.

Contents

1. Part Names
2. Basic Operation
3. Menu Operation
4. USB Media
5. AQUOS LINK and Other Devices
6. Operating the Monitor Using a PC (IP control)
7. Troubleshooting
8. Specifications, etc.

You can select an OSD language from among 7 languages.

English >>

Deutsch >>

Français >>

Italiano >>

Español >>

Русский >>

Polski >>

Ver. 1.15



USB Media

Enjoying Photo

Copying photo

NOTE

- The limit for the file name is up to 80 two-byte or 160 one-byte characters. Files name that exceed the limit cannot be copied.
- If the input source is changed during copying photo, the copying operation will be interrupted.
- If there are photos with the same file names, it will be copied up to 10 items, and "(01) to (10)" will be added at the end of the file name by default.
- When "**All folder**" / "**Current folder**" is specified, only the files that does not exist in destination will be copied.

To remove USB memory that is used as copy destination,
see page [4-20](#).

For information of USB memories that are available for Monitor,
see page [4-2](#).

Contents

1. Part Names
2. Basic Operation
3. Menu Operation
4. USB Media
5. AQUOS LINK and Other Devices
6. Operating the Monitor Using a PC (IP control)
7. Troubleshooting
8. Specifications, etc.

You can select an OSD language from among 7 languages.

English >>
Deutsch >>
Français >>
Italiano >>
Español >>
Русский >>
Polski >>

Ver. 1.15

USB Media



Enjoying Photo

To remove the USB memory that is used as the copy destination

How to operate

1. Press **MENU** to display the Menu, press **▲/▼/◀/▶** to select "**Setup**", and then press **ENTER**
2. Press **▲/▼/◀/▶** to select "**⚙️ (Initial Setup)**" - "**Individual setting**" - "**USB memory setting**", and then press **ENTER**
3. Press **▲/▼** to select "**Remove selected USB memory**", and then press **ENTER**
4. Press **ENTER**
5. Press **ENTER**
6. Remove USB memory

NOTE

- Even after selecting "**Remove selected USB memory**", data in the USB memory can still be viewed through "**USB Media**" until the USB memory is physically removed.
- After selecting "**Remove selected USB memory**", the copy / delete function will not be available. To enable the copy / delete function, remove and reconnect the USB memory physically. (will be automatically specified again)

Contents

1. Part Names
2. Basic Operation
3. Menu Operation
4. USB Media
5. AQUOS LINK and Other Devices
6. Operating the Monitor Using a PC (IP control)
7. Troubleshooting
8. Specifications, etc.

You can select an OSD language from among 7 languages.

English >>
Deutsch >>
Français >>
Italiano >>
Español >>
Русский >>
Polski >>

Ver. 1.15

USB Media



Enjoying Photo

Deleting photo

About this function

- You can delete unnecessary photos stored on a USB memory.

How to operate

1. Press **APPS** on the photo list screen to display the function menu.
2. Use the **▲/▼** button to select "**Delete photo**", and then press **ENTER**
3. Use the **▲/▼** button to select the target file from "**All folder**", "**Current folder**" or "**Selected file**", and then press **ENTER**
- If you select "**Selected file**", the image selection screen is displayed. Use the **▲/▼/◀▶** button and **D** to select the target file, and then press **A**.
4. Use the **▲/▼** button to select "**Yes**", and then press **ENTER**
5. Press **ENTER**

Contents

1. Part Names
2. Basic Operation
3. Menu Operation
4. USB Media
5. AQUOS LINK and Other Devices
6. Operating the Monitor Using a PC (IP control)
7. Troubleshooting
8. Specifications, etc.

You can select an OSD language from among 7 languages.

English >>
Deutsch >>
Français >>
Italiano >>
Español >>
Русский >>
Polski >>

Ver. 1.15



USB Media



Enjoying Music

Playing back music

About this function

- You can play back music file in USB memory.

How to operate

1. Press **INPUT**, followed by **▲▼** to select "**USB media**", and then press **ENTER**
2. Press **◀▶** to select "**Music Mode**", and then press **ENTER**
3. Press **▲▼◀▶** to select a song title, and then press **ENTER**

Contents

1. Part Names
2. Basic Operation
3. Menu Operation
4. USB Media
5. AQUOS LINK and Other Devices
6. Operating the Monitor Using a PC (IP control)
7. Troubleshooting
8. Specifications, etc.

You can select an OSD language from among 7 languages.

English >>
Deutsch >>
Français >>
Italiano >>
Español >>
Русский >>
Polski >>

Ver. 1.15

USB Media



Enjoying Music

Playing music

- Music is played.
- When selecting a folder, music files in that folder will be displayed.
- Press **RETURN** to display the previous screen.
- When there are multiple music files in the same folder as the music file which is being played, the music files in the folder will be played in order, and after the last file is played, the first file will be replayed.
- Press **D** to place check mark at the check box which is on the left side of the music file, then only the selected file will be played. If "**Set all auto play**" is selected from the menu which is displayed after pressing **APPS**, check mark will be placed at all music files, and if "**Reset all auto play**" is selected, check mark will disappear from all music files.
- If "**AV Mode**" is selected from the menu which is displayed after pressing **APPS**, image and sound quality can be changed.
- For information of the setup items for "**AV Mode**", see page [3-6](#).

NOTE

- If there is an invalid music file, an x-mark will be displayed at the file.
- For a variable bit rate file, the playback time displayed may differ from the actual playback time. In addition, playback may stop even if the progress bar display is in progress.

Contents

1. Part Names
2. Basic Operation
3. Menu Operation
4. USB Media
5. AQUOS LINK and Other Devices
6. Operating the Monitor Using a PC (IP control)
7. Troubleshooting
8. Specifications, etc.

You can select an OSD language from among 7 languages.

English >>
Deutsch >>
Français >>
Italiano >>
Español >>
Русский >>
Polski >>

Ver. 1.15

USB Media



Enjoying Music

How to operate during the playback of music
Playing music that is store on USB memory.

RETURN: Returns to the previous step.

A: Plays / stops music playback.

B: Stops playing music.

D: Selects / deselect the music that will be played.

APPS: Displays the function menu.

Contents

1. Part Names
2. Basic Operation
3. Menu Operation
4. USB Media
5. AQUOS LINK and Other Devices
6. Operating the Monitor Using a PC (IP control)
7. Troubleshooting
8. Specifications, etc.

You can select an OSD language from among 7 languages.

English >>
Deutsch >>
Français >>
Italiano >>
Español >>
Русский >>
Polski >>

Ver. 1.15



USB Media



Enjoying Video

Playing video

About this function

- You can play a video from USB memory.

How to operate

1. Press **INPUT**, use ▲▼ to select "**USB media**", and then press **ENTER**.
- Once USB memory is connected, "**USB media**" will be automatically displayed.
2. Press ◀▶ to select "**Video mode**", and then press **ENTER**

Contents

1. Part Names
2. Basic Operation
3. Menu Operation
4. USB Media
5. AQUOS LINK and Other Devices
6. Operating the Monitor Using a PC (IP control)
7. Troubleshooting
8. Specifications, etc.

You can select an OSD language from among 7 languages.

English >>
Deutsch >>
Français >>
Italiano >>
Español >>
Русский >>
Polski >>

Ver. 1.15

USB Media



Enjoying Video

Playing video

3. Use the button to select a video, and then press **ENTER**
 - The video will be played back.
 - If you select a video that you watched halfway through, the video will resume from where you left off.
 - If you select a folder, any videos in the folder will be displayed.
 - **RETURN** allows the preceding screen to be displayed.

NOTE

- If there is an invalid video file, an x-mark is displayed at the file.
- For a variable bit rate file, the playback time displayed may differ from the actual playback time. In addition, it may even end halfway through the progress bar.
- A video that cannot be played back on Monitor may be displayed.
- It is not ensured that any videos displayed can be properly played back.

Resume playback

- Up to 50 videos, which played back halfway through, can be retained by Monitor in reverse chronological order. If you select this, the video resumes from where you left it off the last time.
- Some types of videos may prevent you from resuming playback.

To play back from the beginning

- Use the up / down cursor button to select a video, and press **A**.

Contents

1. Part Names
2. Basic Operation
3. Menu Operation
4. USB Media
5. AQUOS LINK and Other Devices
6. Operating the Monitor Using a PC (IP control)
7. Troubleshooting
8. Specifications, etc.

You can select an OSD language from among 7 languages.

English >>
Deutsch >>
Français >>
Italiano >>
Español >>
Русский >>
Polski >>

Ver. 1.15

USB Media



Enjoying Video

How to operate during the playback of video

1. Press APPS during the playback of VIDEO to the Application menu.
2. Use the ▲/▼ button to select "Operation Panel," and then press ENTER

How to use the operation panel

Playback time/
Total title playback time



Progress bar

· If you select this progress bar, you can move the video playback position forward or backward in increments of 5% of the total video length using the ◀/▶ button.

Operation button

Contents

1. Part Names
2. Basic Operation
3. Menu Operation
4. USB Media
5. AQUOS LINK and Other Devices
6. Operating the Monitor Using a PC (IP control)
7. Troubleshooting
8. Specifications, etc.

You can select an OSD language from among 7 languages.

English >>
Deutsch >>
Français >>
Italiano >>
Español >>
Русский >>
Polski >>

Ver. 1.15

USB Media



Enjoying Video

How to operate during the playback of video

Operations during the playback of video

- You can perform operations such as pausing or playing a video.

▶	Plays the video.
⏸	Pauses the video.
⏮	Fast reverses the video. Press the button down again to speed up.(4 steps)
⏪	Returns to the beginning of the chapter being viewed now.
⏩	Fast forward the video. Press the button down again to speed up.(4 steps)
⏭	Locates the beginning of the next chapter.
■	Stops playback of the video, and returns to the video list screen.
-10 SEC	Rewinds the video by 10 seconds.
+30 SEC	Fast forward the video by about 30 seconds.

NOTE

- Some types of videos may prevent you from performing certain button operations.
- Available operations vary depending on the video viewed. Unavailable buttons are not displayed.
- Playback time can be navigated using the 10 sec REWIND / 30 SEC FF (approximate time) operations.xs
- During the speeding up or slowing down of playback, there may be no audio output.

Contents

1. Part Names
2. Basic Operation
3. Menu Operation
4. USB Media
5. AQUOS LINK and Other Devices
6. Operating the Monitor Using a PC (IP control)
7. Troubleshooting
8. Specifications, etc.

You can select an OSD language from among 7 languages.

English >>
 Deutsch >>
 Français >>
 Italiano >>
 Español >>
 Русский >>
 Polski >>

Ver. 1.15

AQUOS LINK and Other Devices

Connecting 8K output compatible Device

Connecting 4 pieces of HDMI cable (8K output compatible device) to INPUT 7 (A / B / C / D)

Connecting to 8K output compatible device

- Connects the Monitor to 8K output (7680 × 4320 of resolution output) compatible equipment by using 4 HDMI cables.
- When connecting an 8K output compatible device to the Monitor, use commercially available premium HDMI cables.
- Connect the devices properly so that the output signal from the 8K output compatible device can be displayed at the appropriate position.
Video images from the HDMI input terminal are displayed at the position as shown on the right.
- INPUT 7 (A to D) are 8K input-specific terminals.
- Multi-screen display by using 8K signal is not supported.
- 8K display is possible whenever any input signal to INPUT 7 (A to D) is synchronized.
- Under the factory default setting, INPUT7-A is set as the sound input.
- To change the factory default setting, switch to INPUT7, select "**Setup**" - "**Option**" - "**Terminal setting**" - "**INPUT7 audio select**" from the Menu, and then select input for audio sound.
- Read the operation manual on the device to be connected to the Monitor as well.

◆Important◆

- Use / connect four HDMI cables of the same type and brand, otherwise performance cannot be guaranteed.
- Input the format 3840×2160 (24Hz, 25Hz, 30Hz, 50Hz, 60Hz) to each terminal of INPUT 7 (A to D).
If any format other than the above is input, the video or picture may be distorted.

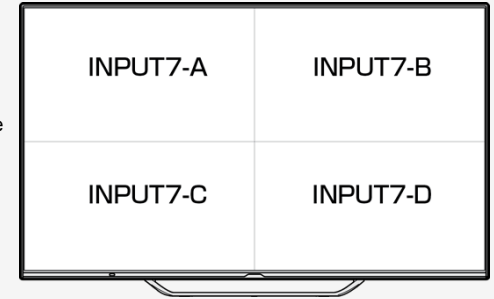

Contents

1. Part Names
2. Basic Operation
3. Menu Operation
4. USB Media
5. AQUOS LINK and Other Devices
6. Operating the Monitor Using a PC (IP control)
7. Troubleshooting
8. Specifications, etc.

You can select an OSD language from among 7 languages.

English >>

Deutsch >>

Français >>

Italiano >>

Español >>

Русский >>

Polski >>

Ver. 1.15

AQUOS LINK and Other Devices

Connecting 8K output compatible Device

Connect four HDMI cables (8K output compatible device)

- A commercially available premium HDMI cable is required.

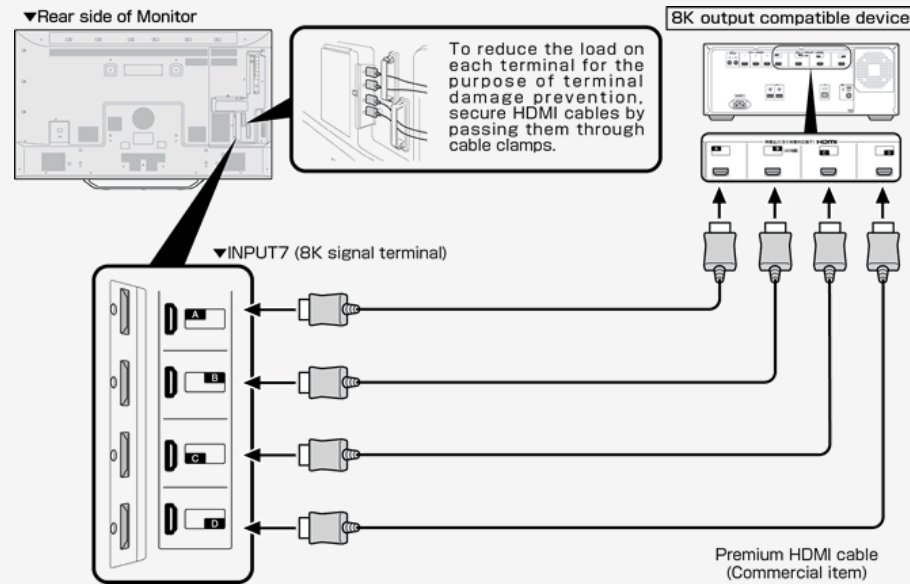

Contents

1. Part Names
2. Basic Operation
3. Menu Operation
4. USB Media
5. AQUOS LINK and Other Devices
6. Operating the Monitor Using a PC (IP control)
7. Troubleshooting
8. Specifications, etc.

You can select an OSD language from among 7 languages.

English >>
Deutsch >>
Français >>
Italiano >>
Español >>
Русский >>
Polski >>

Ver. 1.15

AQUOS LINK and Other Devices



Connecting 8K output compatible Device

Supported format

- 7680 × 4320 (24Hz, 25Hz, 30Hz, 50Hz, 60Hz)

How to switch to 8K video input

- Press **INPUT** on the remote control. During the display of the input change menu, use the ▲▼ to select "**INPUT7**", and press **ENTER**.

Channel number to be displayed during use of 8K video input

- When a synchronizing 8K signal is input to INPUT7 (A to D), the video information is displayed as "**4320p**".

NOTE

- "**Out of range**" message will be displayed if an unsupported signal is input. In such situation, refer to the operation manual of the connected device and change to the supported signal.
- Video will not be displayed properly if input signals are not synchronized.

Contents

1. Part Names
2. Basic Operation
3. Menu Operation
4. USB Media
5. AQUOS LINK and Other Devices
6. Operating the Monitor Using a PC (IP control)
7. Troubleshooting
8. Specifications, etc.

You can select an OSD language from among 7 languages.

English >>
Deutsch >>
Français >>
Italiano >>
Español >>
Русский >>
Polski >>

Ver. 1.15

AQUOS LINK and Other Devices



Connecting 8K output compatible Device

Supported audio sound signals

- Type: Linear PCM
- Sampling frequency: 48kHz / 44.1kHz / 32kHz

How to change the input audio sound

- Press **INPUT** on the remote control. During the display of the input change menu, press **▲/▼** to select "**INPUT7**", and press **ENTER**. Press **MENU**, followed by **▲/▼/◀/▶** and **ENTER** to select "**Setup**" - "**Option**" - "**Terminal setting**" - "**INPUT7 audio select**", then select input for audio sound.

NOTE

- When "**Audio input terminal**" has been selected for "**INPUT7 audio select**", no sound will come out of the Monitor if you connect between the Monitor and a typical HDMI compatible device using an HDMI cable instead of an analog audio cable. (An analog audio cable needs to be connected)
To connect the Monitor to a HDMI compatible device using an HDMI cable alone, select the input to which the device has been connected in "**INPUT7 audio select**".

Contents

1. Part Names
2. Basic Operation
3. Menu Operation
4. USB Media
5. AQUOS LINK and Other Devices
6. Operating the Monitor Using a PC (IP control)
7. Troubleshooting
8. Specifications, etc.

You can select an OSD language from among 7 languages.

- English >>
- Deutsch >>
- Français >>
- Italiano >>
- Español >>
- Русский >>
- Polski >>

Ver. 1.15

AQUOS LINK and Other Devices

Connecting 4K output compatible Device

Connecting a 4K output compatible BD recorder

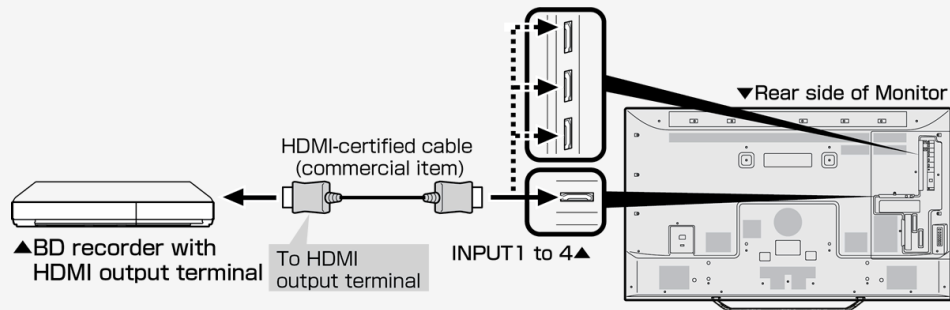

Connecting a 4K output compatible AV amplifier

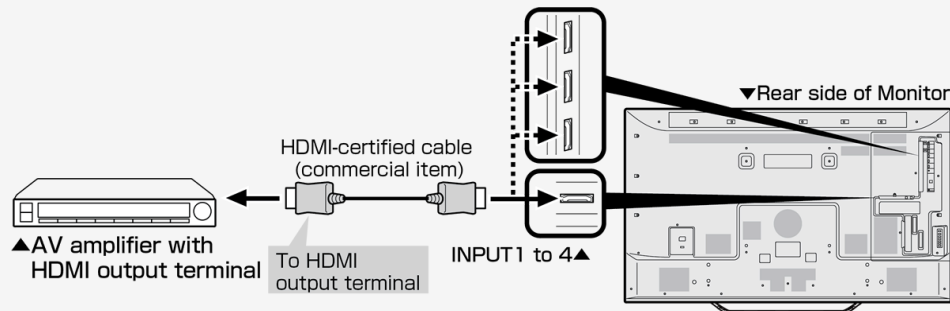

NOTE

- A commercially available premium HDMI cable is required.
- Only INPUT 1 supports for 4K50p/60P (4:2:2, 4:4:4) signals.

Contents

1. Part Names
2. Basic Operation
3. Menu Operation
4. USB Media
5. AQUOS LINK and Other Devices
6. Operating the Monitor Using a PC (IP control)
7. Troubleshooting
8. Specifications, etc.

You can select an OSD language from among 7 languages.

English >>

Deutsch >>

Français >>

Italiano >>

Español >>

Русский >>

Polski >>

Ver. 1.15

AQUOS LINK and Other Devices

Connecting 4K output compatible Device

Connecting 4K output compatible device

- Use a PC that supports 4K output (resolution output of 3840 × 2160).

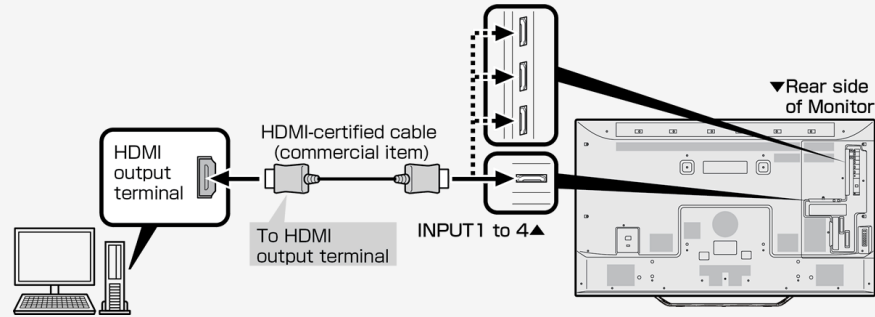

NOTE

- A commercially available HDMI-certified cable (Premium HDMI cable) is required.
- Only INPUT 1 supports for 4K50p/60P (4:2:2., 4:4:4) signals.

Contents

1. Part Names
2. Basic Operation
3. Menu Operation
4. USB Media
5. AQUOS LINK and Other Devices
6. Operating the Monitor Using a PC (IP control)
7. Troubleshooting
8. Specifications, etc.

You can select an OSD language from among 7 languages.

English >>
Deutsch >>
Français >>
Italiano >>
Español >>
Русский >>
Polski >>

Ver. 1.15

AQUOS LINK and Other Devices



Viewing HDR Video (INPUT1, INPUT7)

- This Monitor provides support for HDR (High Dynamic Range) supported by "ULTRA HD Blu-ray™". Ever-more brightness information is included on HDR video, making it possible to express the gradation of bright and dark areas in the HDR video. This was previously impossible to express in videos such as ones with a high contrast between bright and dark areas, and thereby offering high-contrast, realistic video images.
- To view a HDR video using INPUT 1 of the Monitor, connect a HDR-capable device to INPUT 1, and set "**Suitable mode for signals**" to "**Full mode (HDR)**".
- When **INPUT7** is selected, you can use a HDR compatible device with the default setting.
 1. Press **INPUT**, use the **▲▼** to select "**INPUT 1**", and then press **ENTER**
 2. Press **MENU** to display the Menu, press **▲▼/◀▶** to select "**Setup**", and then press **ENTER**
 3. Press **▲▼/◀▶** to select "**(Option)**" - "**Terminal setting**", and press **ENTER**
 4. Press **▲▼** to select "**Suitable mode for signals**", and press **ENTER**
 5. Press **▲▼** to select "**Full mode (HDR)**", and press **ENTER**

NOTE

- During "**Full mode (HDR)**", "**OPC**" (page [3-9](#)) and "**Backlight**" (page [3-10](#)) can be adjusted respectively for HDR and SDR video contents.
- HDR and SDR video content signals are identified automatically.

Contents

1. Part Names
2. Basic Operation
3. Menu Operation
4. USB Media
5. AQUOS LINK and Other Devices
6. Operating the Monitor Using a PC (IP control)
7. Troubleshooting
8. Specifications, etc.

You can select an OSD language from among 7 languages.

- English >>
- Deutsch >>
- Français >>
- Italiano >>
- Español >>
- Русский >>
- Polski >>

Ver. 1.15

AQUOS LINK and Other Devices



Viewing HDR Video (INPUT1, INPUT7)

Adjusting an HDR video to be either brightness-oriented or tone-oriented.

1. Press **MENU** to display the Menu, use the **▲/▼/◀/▶** to select "**Setup**", and then press **ENTER**
2. Press **▲/▼/◀/▶** to select "**Picture**" - "**Advanced**", and press **ENTER**
3. Press **▲/▼** to select "**Dynamic range expand setting**", and press **ENTER**
4. Make adjustments using the **◀/▶** button
 - The video will be brightness-oriented if it is set to a larger value. The video will be tone-oriented if it is set to a smaller value.

NOTE

- This selection is only available during the input of HDR signal.
- When HDR video contents are input, the "HDR" icon is displayed on the screen.

Contents

1. Part Names
2. Basic Operation
3. Menu Operation
4. USB Media
5. AQUOS LINK and Other Devices
6. Operating the Monitor Using a PC (IP control)
7. Troubleshooting
8. Specifications, etc.

You can select an OSD language from among 7 languages.

English >>

Deutsch >>

Français >>

Italiano >>

Español >>

Русский >>

Polski >>

Ver. 1.15

AQUOS LINK and Other Devices

Using the AQUOS LINK

What is AQUOS LINK?

- HDMI terminals are not limited to video or audio signals but it permits control signals, which allow for device-to-device control, which is transmitted through the HDMI cable. AQUOS LINK adopts this HDMI CEC (Consumer Electronics Control) standard, which allows for mutual device-to-device control, so that SHARP's products, such as LCD TV, recorder, and AV amplifier, can mutually control each other for smooth cooperation.

NOTE

- AQUOS LINK functions are performed with INPUT 1 through 4. They are not available with INPUT 7 (8K).
- To operate AQUOS LINK using the remote control, point the remote control at the Monitor. AQUOS recorder is not designed to directly receive signals from the remote control.

One-touch recording of the program you are watching

Scheduled recording of a program shown by TV program information

Easy playback of recorded program

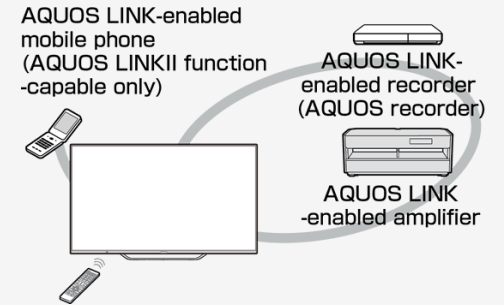

Contents

1. Part Names
2. Basic Operation
3. Menu Operation
4. USB Media
5. AQUOS LINK and Other Devices
6. Operating the Monitor Using a PC (IP control)
7. Troubleshooting
8. Specifications, etc.

You can select an OSD language from among 7 languages.

English >>

Deutsch >>

Français >>

Italiano >>

Español >>

Русский >>

Polski >>

Ver. 1.15



AQUOS LINK and Other Devices

Using the AQUOS LINK

Before using AQUOS LINK functions

1. Connect to an AQUOS LINK-enabled device
 - With a commercially available HDMI-certified cable, connect an AQUOS LINK-compatible device and the Monitor using a commercially available HDMI-certified cable.
2. Configuring the settings.
 - Settings (pages [5-11](#) to [5-14](#)) have to be configured to use the AQUOS LINK - compatible device.
 - Settings must also be configured for the recorder. Read the operation manual of the device before configuring the settings.

Contents

1. Part Names
2. Basic Operation
3. Menu Operation
4. USB Media
5. AQUOS LINK and Other Devices
6. Operating the Monitor Using a PC (IP control)
7. Troubleshooting
8. Specifications, etc.

You can select an OSD language from among 7 languages.

English >>
Deutsch >>
Français >>
Italiano >>
Español >>
Русский >>
Polski >>

Ver. 1.15

AQUOS LINK and Other Devices

Using the AQUOS LINK

Settings to use AQUOS LINK functions

Automatically starting the Monitor using AQUOS LINK-enabled device

- Setting the Monitor to automatically turn on when an AQUOS LINK-compatible device is operating.
 1. Press **OPTION**, followed by ▲▼ to select "**Control menu**", and then press **ENTER**
 2. Select "**AQUOS LINK setup**", and press **ENTER**
 3. Select "**Auto power on**", and set it to "**Yes**"



Contents

1. Part Names
2. Basic Operation
3. Menu Operation
4. USB Media
5. AQUOS LINK and Other Devices
6. Operating the Monitor Using a PC (IP control)
7. Troubleshooting
8. Specifications, etc.

You can select an OSD language from among 7 languages.

English >>
Deutsch >>
Français >>
Italiano >>
Español >>
Русский >>
Polski >>

Ver. 1.15

AQUOS LINK and Other Devices

Using the AQUOS LINK

Settings to use AQUOS LINK functions

Selecting a device to be used for AQUOS LINK functions.

- This is a setting to be made when a device is connected to the Monitor. The device can be selected for AQUOS LINK function.
 1. Press **OPTION**, followed by ▲▼ to select "**Control menu**", and then press **ENTER**
 2. Select "**AQUOS LINK Setup**", and press **ENTER**
 3. Select "**Select AQUOS LINK device**", and press **ENTER**
 4. Select a device to be used for AQUOS LINK function, and then press **ENTER**.



Contents

1. Part Names
2. Basic Operation
3. Menu Operation
4. USB Media
5. AQUOS LINK and Other Devices
6. Operating the Monitor Using a PC (IP control)
7. Troubleshooting
8. Specifications, etc.

You can select an OSD language from among 7 languages.

English >>
Deutsch >>
Français >>
Italiano >>
Español >>
Русский >>
Polski >>

Ver. 1.15

AQUOS LINK and Other Devices

Using the AQUOS LINK

Settings to use AQUOS LINK functions

You can set the remote control of the monitor to use AQUOS LINK functions such as selecting channels in AQUOS recorder.

This setting should be made for each input terminal respectively.

1. Press **OPTION**, followed by **▲/▼** to select "**Control menu**", and then press **ENTER**
2. Select "**AQUOS LINK Setup**", and press **ENTER**
3. Select "**Selecting channel key**", and press **ENTER**
4. Select the input to which the device to be operated with the remote control is connected, and press **ENTER**
5. Select "**On**", and press **ENTER**
 - For "**Auto**", a device operates in the same manner as it does when this is set to "**Off**". However, only when there is a request from a connected device, it will operate in the same manner as it does when this is set to "**On**".



Contents

1. Part Names
2. Basic Operation
3. Menu Operation
4. USB Media
5. AQUOS LINK and Other Devices
6. Operating the Monitor Using a PC (IP control)
7. Troubleshooting
8. Specifications, etc.

You can select an OSD language from among 7 languages.

English >>
Deutsch >>
Français >>
Italiano >>
Español >>
Русский >>
Polski >>

Ver. 1.15

AQUOS LINK and Other Devices

Using the AQUOS LINK

Settings to use AQUOS LINK functions

If an HDMI device that is not AQUOS LINK-compatible malfunctions.

- If an HDMI device that is not an AQUOS LINK compatible is connected to the monitor and it malfunctions such as the power turns on and off, or channel switches on its own, configure this setting.
 1. Press **OPTION**, followed by **▲/▼** to select "**Control menu**", and then press **ENTER**
 2. Select "**AQUOS LINK setup**", and press **ENTER**
 3. Select "**AQUOS LINK control**", and set it to "**Off**"



Contents

1. Part Names
2. Basic Operation
3. Menu Operation
4. USB Media
5. AQUOS LINK and Other Devices
6. Operating the Monitor Using a PC (IP control)
7. Troubleshooting
8. Specifications, etc.

You can select an OSD language from among 7 languages.

- English >>
- Deutsch >>
- Français >>
- Italiano >>
- Español >>
- Русский >>
- Polski >>

Ver. 1.15

AQUOS LINK and Other Devices

Connecting Recorder, Player, etc.

To connect through HDMI terminals

- Check the output terminals of your recorder or player, and connect to a terminal that is capable of high definition / high image quality.

NOTE

- For information on video types and image quality, page [5-16](#)
- Even with a high-definition- / high-image-quality-capable terminal, a video input of standard image quality will be of standard quality.
- For information on connections, see page [5-17](#).
- When the Monitor is connected to an AQUOS LINK-compatible recorder, you can operate the recorder with the remote control.
- For information on connection to INPUT 7 (8K signal), see page [5-2](#).

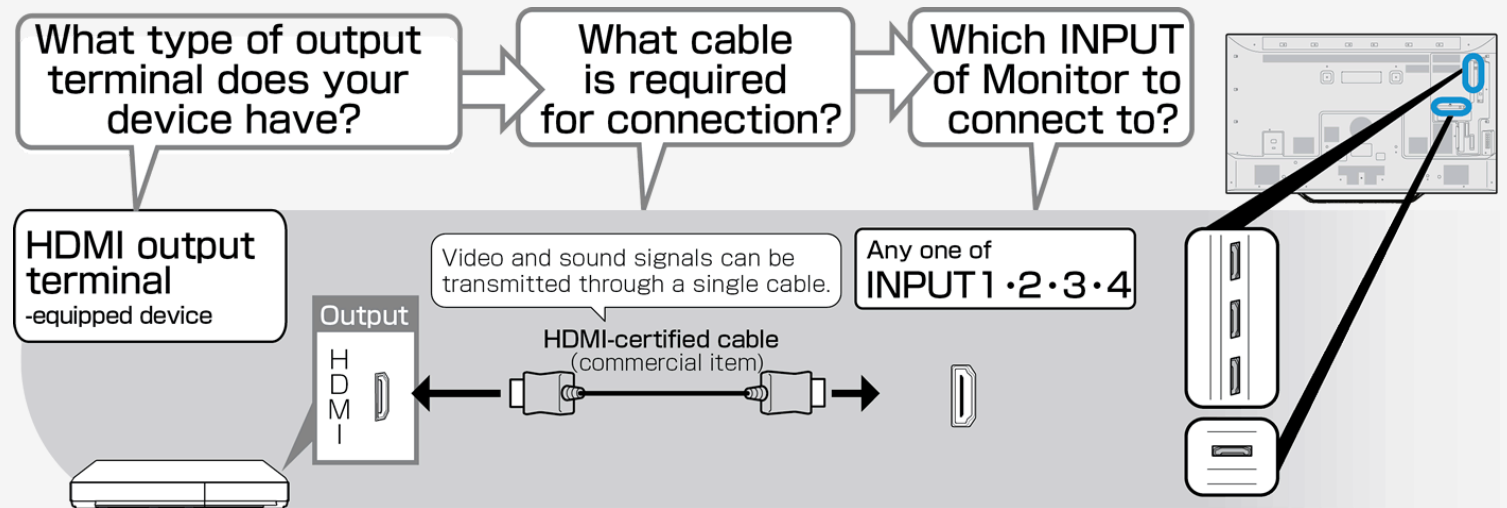

Contents

1. Part Names
2. Basic Operation
3. Menu Operation
4. USB Media
5. AQUOS LINK and Other Devices
6. Operating the Monitor Using a PC (IP control)
7. Troubleshooting
8. Specifications, etc.

You can select an OSD language from among 7 languages.

English >>

Deutsch >>

Français >>

Italiano >>

Español >>

Русский >>

Polski >>

Ver. 1.15

AQUOS LINK and Other Devices

Connecting Recorder, Player, etc.

To connect through video terminals

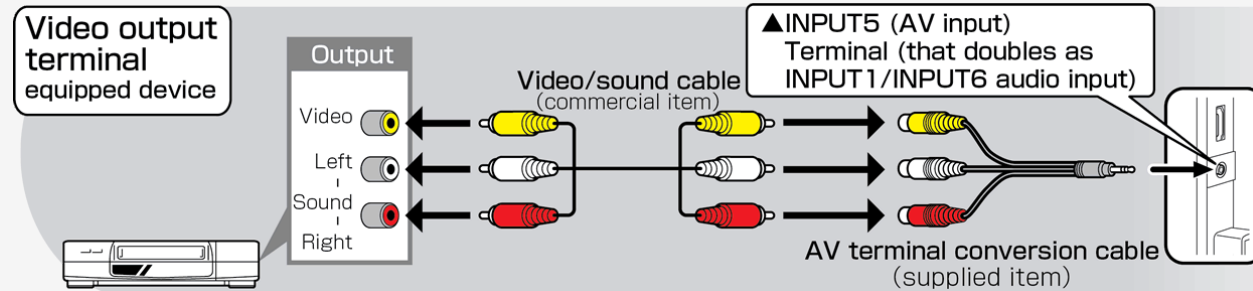

NOTE

- Connect each video / audio cable to the terminal of the same color as its tip (yellow cable connects to yellow terminal, and white / red cables to white / red terminals, respectively).
- To play a commercially available Blu-ray Disc in a recorder or player, connect between the recorder or player and the Monitor through an HDMI cable. There may be no video or audio / sound output from a blu-ray disc in a Digital Rights Management-based recorder or player.

Contents

1. Part Names
2. Basic Operation
3. Menu Operation
4. USB Media
5. AQUOS LINK and Other Devices
6. Operating the Monitor Using a PC (IP control)
7. Troubleshooting
8. Specifications, etc.

You can select an OSD language from among 7 languages.

English >>

Deutsch >>

Français >>

Italiano >>

Español >>

Русский >>

Polski >>

Ver. 1.15

AQUOS LINK and Other Devices

Connecting Recorder, Player, etc.

For a device with an HDMI output terminal

- HDMI terminals allow video and audio signals to be transmitted through an HDMI-certified cable (commercial product).
- Be sure to use a commercially available HDMI-certified product (Premium HDMI cable).
If you use a cable that is not HDMI-certified, a malfunction may occur, such as a failure to display a video or operate AQUOS LINK, no sound coming from the Monitor, or a noise in video.
- If any of the following apply, use a Premium HDMI cable.
 - When connecting to a device that is 4K2K output compatible
 - When inputting a video signal (1080p)
- For information on connection to INPUT 7 (8K signal), see page [5-2](#).

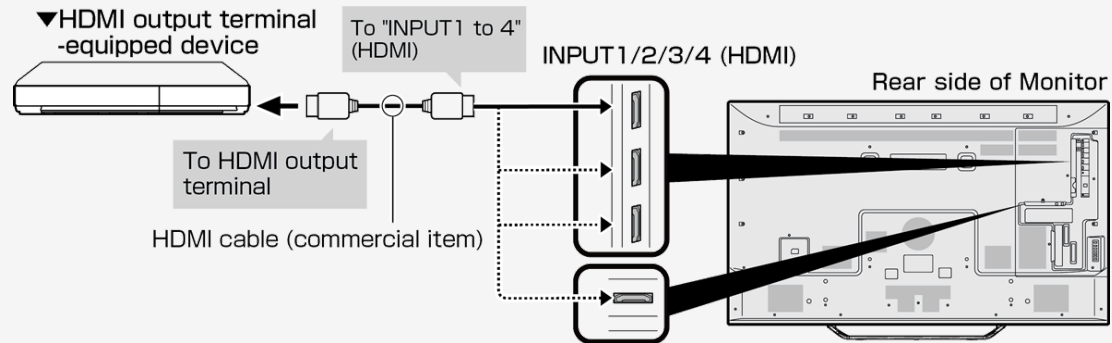

- When playing back a 4K60p video or an HDR video from ULTRA HD Blu-ray™, connect to INPUT1 of the Monitor through a 18Gbps-capable cable certified as a "premium HDMI cable".

Contents

1. Part Names
2. Basic Operation
3. Menu Operation
4. USB Media
5. AQUOS LINK and Other Devices
6. Operating the Monitor Using a PC (IP control)
7. Troubleshooting
8. Specifications, etc.

You can select an OSD language from among 7 languages.

English >>

Deutsch >>

Français >>

Italiano >>

Español >>

Русский >>

Polski >>

Ver. 1.15

AQUOS LINK and Other Devices

Connecting Recorder, Player, etc.

For a device with an HDMI output terminal (INPUT 1 / 2 / 3 / 4)

Supported video signals

- 3840 × 2160 (24Hz/25Hz/30Hz/50Hz/60Hz*), 1080p (24Hz/30Hz/50Hz/60Hz), 720p (30Hz/50Hz/60Hz), 1080i, 576p, 576i, 480p, 480i, VGA, SVGA, XGA, WXGA, SXGA, SXGA+

*Only INPUT 1 supports for 4K50p/60p (4:2:2, 4:4:4) signals.

Supported audio sound signals

- Type: Linear PCM (2ch)*¹, AAC*², Dolby Digital, Dolby Digital Plus
sampling frequency: 48kHz / 44.1kHz / 32kHz

*1 Only Linear PCM is supported (INPUT 7) during viewing 8K video.

*2 Since digital broadcasting makes efficient use of limited radio waves, videos or sounds are compressed before being transmitted.

AAC is an audio compression format that is used in digital broadcasting, and that, in spite of a high compression ratio, can achieve high sound quality and even support multi-channel audio (5.1 channel surround, etc.).

NOTE

- If a device that is not AQUOS LINK-compatible is connected to the monitor, it may turn on and off, or switch channels on its own. In this case, set "AQUOS LINK control" to "Off".
(page [5-14](#))

Contents

1. Part Names
2. Basic Operation
3. Menu Operation
4. USB Media
5. AQUOS LINK and Other Devices
6. Operating the Monitor Using a PC (IP control)
7. Troubleshooting
8. Specifications, etc.

You can select an OSD language from among 7 languages.

English >>

Deutsch >>

Français >>

Italiano >>

Español >>

Русский >>

Polski >>

Ver. 1.15

AQUOS LINK and Other Devices

Connecting Recorder, Player, etc.

For a device with a video output terminal (connection for playback)

- Do not turn on the Monitor and recording device before completing connection between the Monitor and the recording device.

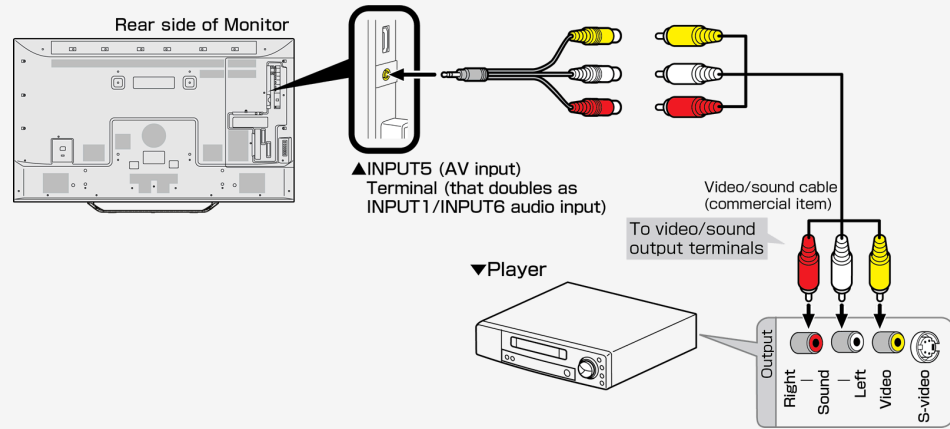

- Connect each video / audio cable to the terminal of the same color as its tip (yellow cable connects to yellow terminal, and white / red cables to white / red terminals, respectively).
- Be sure to use the supplied conversion cable. When using any conversion cable other than the supplied one, the Monitor may not operate properly, or breakages may occur.

Contents

1. Part Names
2. Basic Operation
3. Menu Operation
4. USB Media
5. AQUOS LINK and Other Devices
6. Operating the Monitor Using a PC (IP control)
7. Troubleshooting
8. Specifications, etc.

You can select an OSD language from among 7 languages.

English >>
Deutsch >>
Français >>
Italiano >>
Español >>
Русский >>
Polski >>

Ver. 1.15

AQUOS LINK and Other Devices

Connecting Recorder, Player, etc.

Switching to the screen of a BD recorder, etc.

- Switching to the screen of HDMI output allows you to watch BD or DVD video.

The underlined step describes the operation of an external device such as BD recorder.

1. Connect a BD recorder to the Monitor, and press its power button to turn on the BD recorder
2. Insert a disk you want to play back.
3. Press **INPUT** to display the input change menu.
 - Perform the operation on page [5-21](#) during the display of the menu.



Contents

1. Part Names
2. Basic Operation
3. Menu Operation
4. USB Media
5. AQUOS LINK and Other Devices
6. Operating the Monitor Using a PC (IP control)
7. Troubleshooting
8. Specifications, etc.

You can select an OSD language from among 7 languages.

English >>
Deutsch >>
Français >>
Italiano >>
Español >>
Русский >>
Polski >>

Ver. 1.15

AQUOS LINK and Other Devices

Connecting Recorder, Player, etc.

Switching to the screen of a BD recorder, etc.

The underlined step describes the operation of an external device such as BD recorder.

4. Press **INPUT** repeatedly to select the name of the input to which the device is connected
 - It can also be selected by using the ▲▼ button.
 (e.g.) To view a video from the device connect to INPUT 1 of the Monitor, select "**INPUT1**"
 Selectable input
 - "**INPUT5**" can be selected only when a video device is connected to the Monitor.
5. Play a video from a BD recorder
 - A video is played on the Monitor.
 - Some external devices may require a setting be made to output a video. For information on how to make the setting, refer to the operation manual for the BD recorder connected to the Monitor.



Contents

1. Part Names
2. Basic Operation
3. Menu Operation
4. USB Media
5. AQUOS LINK and Other Devices
6. Operating the Monitor Using a PC (IP control)
7. Troubleshooting
8. Specifications, etc.

You can select an OSD language from among 7 languages.

English >>
Deutsch >>
Français >>
Italiano >>
Español >>
Русский >>
Polski >>

Ver. 1.15

AQUOS LINK and Other Devices

Connecting Recorder, Player, etc.

Switching to the screen of a BD recorder, etc.

To change displayed name of input source as desired

- The device names displayed in the input menu, etc. can be changed to the names of the devices connected to INPUT1 to 7.
1. Press **INPUT**, followed by **▲/▼** to select any input to be renamed (INPUT1 to 7), and then press **ENTER**
 2. Press **MENU** to display the Menu, followed by **▲/▼/◀/▶** to select "**Setup**", and then press **ENTER**
 3. Press **▲/▼/◀/▶** to select **OPTION** - "**Terminal setting**"
 4. Press **▲/▼** to select "**Input label**", and then select the name to be displayed
 - If you want to input a desired device name, select "**EDIT**" and determine the name. (Entering Letters page [3-45](#))



Contents

1. Part Names
2. Basic Operation
3. Menu Operation
4. USB Media
5. AQUOS LINK and Other Devices
6. Operating the Monitor Using a PC (IP control)
7. Troubleshooting
8. Specifications, etc.

You can select an OSD language from among 7 languages.

English >>
Deutsch >>
Français >>
Italiano >>
Español >>
Русский >>
Polski >>

Ver. 1.15

AQUOS LINK and Other Devices

Connecting Recorder, Player, etc.

Switching to the screen of a BD recorder, etc.

To skip unused inputs

- Unused inputs (INPUT1 to 4, INPUT6, INPUT7, USB Media)
 1. Press **MENU** to display the Menu, followed by **▲/▼/◀/▶** to select "**Setup**", and then press **ENTER**
 2. Press **▲/▼/◀/▶** to select **OPTION** - "**Terminal setting**"
 3. Press **▲/▼** to select "**Input skip**", and then press **ENTER**
 4. Press **▲/▼** to select an input you want to skip, and then set the input to "**Yes**"
 - To cancel the input skip, select "**No**".



Contents

1. Part Names
2. Basic Operation
3. Menu Operation
4. USB Media
5. AQUOS LINK and Other Devices
6. Operating the Monitor Using a PC (IP control)
7. Troubleshooting
8. Specifications, etc.

You can select an OSD language from among 7 languages.

English >>

Deutsch >>

Français >>

Italiano >>

Español >>

Русский >>

Polski >>

Ver. 1.15



AQUOS LINK and Other Devices

Connecting Recorder, Player, etc.

Switching to the screen of a BD recorder, etc.

When connecting a video game console.

- You can connect and play video game console in all INPUT. In case you play video game in INPUT7, you can feel better response in PC mode.

Contents

1. Part Names
2. Basic Operation
3. Menu Operation
4. USB Media
5. AQUOS LINK and Other Devices
6. Operating the Monitor Using a PC (IP control)
7. Troubleshooting
8. Specifications, etc.

You can select an OSD language from among 7 languages.

English >>
Deutsch >>
Français >>
Italiano >>
Español >>
Русский >>
Polski >>

Ver. 1.15

AQUOS LINK and Other Devices



Connecting Recorder, Player or Game Player

Switching to the screen of a BD recorder, video game console, etc.

When connecting a video game console

The game play time is displayed every half an hour (game time display setting).

- It is a function that notifies one of the elapsed time to prevent her / him from losing track of time playing games
- Press **MENU** to display the Menu, followed by **▲▼/◀▶** and **ENTER**

to select "**Setup**" - "**(Ecology)**" - "**Game play time**" where you will make the setting.
(It will be displayed when INPUT1 to 6 is selected.)

Item	Description
On	<ul style="list-style-type: none"> • When it is set to the game mode and an external input is used, a message appears at the bottom left corner of the screen every half hour after the start of a game.
Off	<ul style="list-style-type: none"> • Nothing appears.

Important

- To display the elapsed time, set the "**AV Mode**" (page [3-8](#)) of the input, to which a video game console has been connected, to "**USER**" before starting a game.
- It is enabled only during viewing an external input.

Contents

1. Part Names
2. Basic Operation
3. Menu Operation
4. USB Media
5. AQUOS LINK and Other Devices
6. Operating the Monitor Using a PC (IP control)
7. Troubleshooting
8. Specifications, etc.

You can select an OSD language from among 7 languages.

English >>

Deutsch >>

Français >>

Italiano >>

Español >>

Русский >>

Polski >>

Ver. 1.15

AQUOS LINK and Other Devices

Connecting Audio Device

- You can connect an audio device to the Monitor and enjoy impressive sound quality and volume.

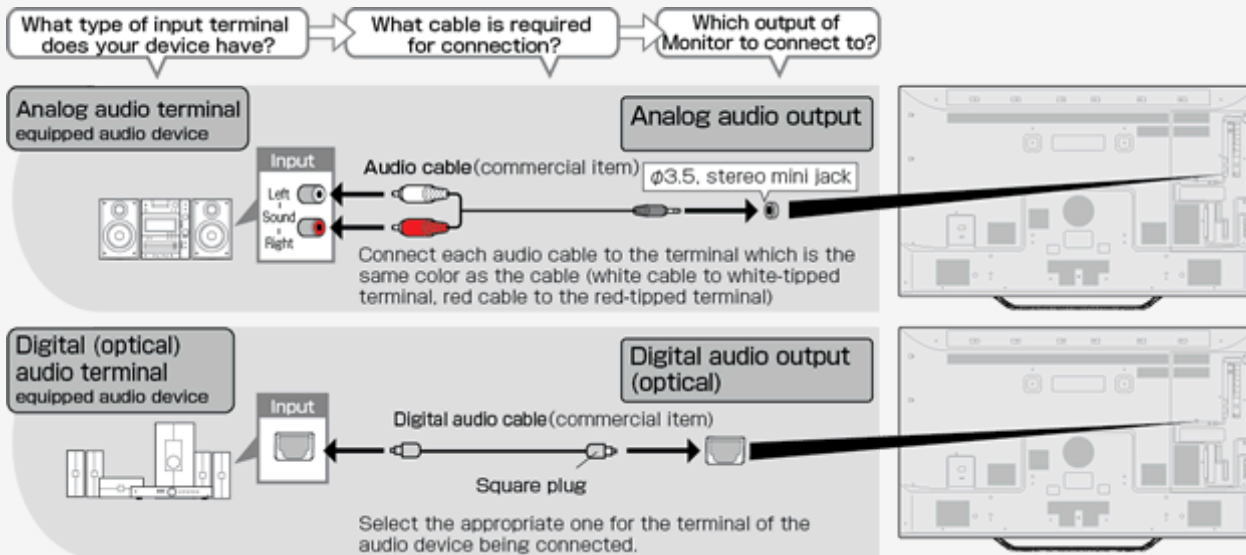

NOTE

- The supplied conversion cable cannot be used in analog audio output applications. If the supplied conversion cable is used, one side of the audio will fail to output properly.

Contents

1. Part Names
2. Basic Operation
3. Menu Operation
4. USB Media
5. AQUOS LINK and Other Devices
6. Operating the Monitor Using a PC (IP control)
7. Troubleshooting
8. Specifications, etc.

You can select an OSD language from among 7 languages.

English >>
Deutsch >>
Français >>
Italiano >>
Español >>
Русский >>
Polski >>

Ver. 1.15

AQUOS LINK and Other Devices

Connecting PC

Using as a monitor for PC

- Before connecting a PC to the Monitor, check the output resolution of the PC. If the PC does not provide support for the following resolutions, the PC screen cannot be displayed on the Monitor.
- For the connection method, check pages [5-31](#) to [5-33](#).

The resolutions supported by the Monitor's INPUT 1 to 4 and INPUT 6

Resolution (pixel)		Horizontal frequency (kHz)	Vertical frequency (Hz)	VESA standards	Resolution (pixel)		Horizontal frequency (kHz)	Vertical frequency (Hz)	VESA standards
VGA	720 x 400	31.5	70		WXGA	1280 x 800	49.7	60	○
	640 x 480	31.5	60	○		1366 x 768	47.7	60	○
		37.9	72	○	SXGA	1280 x 1024	64.0	60	○
		37.5	75	○	SXGA+	1400 x 1050	65.3	60	○
SVGA	800 x 600	35.1	56	○	480p	720 x 480	31.5	60	
		37.9	60	○	* 1080i	1920 x 1080	33.8	60	
		48.1	72	○	720p	1280 x 720	45.0	60	
		46.9	75	○	1080p	1920 x 1080	67.5	60	
		48.4	60	○	* 4K	3840 x 2160	53.95	24	
56.5	70	○	67.5	30					
60.0	75	○	135.0	60					

*During HDMI input only

Contents

1. Part Names
2. Basic Operation
3. Menu Operation
4. USB Media
5. AQUOS LINK and Other Devices
6. Operating the Monitor Using a PC (IP control)
7. Troubleshooting
8. Specifications, etc.

You can select an OSD language from among 7 languages.

English >>

Deutsch >>

Français >>

Italiano >>

Español >>

Русский >>

Polski >>

Ver. 1.15



AQUOS LINK and Other Devices

Connecting PC

Using as a monitor for PC

NOTE

- When a certain type of PC is connected to the Monitor, the PC screen may fail to display properly or completely even if the input signal is supported by the Monitor.
- **"Out of range"** message will be displayed if an unsupported signal is input. In such situation, refer to the operation manual of the connected device and change to the supported signal.
- The selectable screen size may vary depending on the input signal from PC. For information on the screen size types, see page [5-29](#).
- For particular input signals, on-screen letters may appear blurred if certain conditions are met.

Contents

1. Part Names
2. Basic Operation
3. Menu Operation
4. USB Media
5. AQUOS LINK and Other Devices
6. Operating the Monitor Using a PC (IP control)
7. Troubleshooting
8. Specifications, etc.

You can select an OSD language from among 7 languages.

English >>

Deutsch >>

Français >>

Italiano >>

Español >>

Русский >>

Polski >>

Ver. 1.15











AQUOS LINK and Other Devices

Connecting PC

Using as a monitor for PC

Selectable screen size for the Monitor (The selectable screen sizes may vary depending on the input signal from PC.)

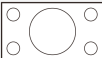
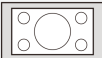
Input signal	Normal	Zoom	Full	Dot by Dot
Video image being vertically longer than 16:9  640×480, 800×600, 1024×768, 1280×1024, etc.	 Appears as shown by the drawing, without disturbing the aspect ratio for the input signal	 Appears enlarged laterally to the limit of the screen. Cuts off the top and bottom of the video image.	 Appears full screen.	 Displayed to the input signal resolution.
16:9 video image 			 Appears full screen.	 Displayed to the input signal resolution.

Contents

1. Part Names
2. Basic Operation
3. Menu Operation
4. USB Media
5. AQUOS LINK and Other Devices
6. Operating the Monitor Using a PC (IP control)
7. Troubleshooting
8. Specifications, etc.

You can select an OSD language from among 7 languages.

English >>
Deutsch >>
Français >>
Italiano >>
Español >>
Русский >>
Polski >>

Ver. 1.15

AQUOS LINK and Other Devices



Connecting PC

Using as a monitor for PC

Displaying the PC screen / selecting the screen size

1. Turn on PC
2. Press **INPUT** to display the input change menu, and after selecting the input to which the PC has been connected with the **▲▼** button, press **ENTER**
 - The PC screen will be displayed.
3. Press **MENU** to display the Menu, select "**Setup**" with the **▲▼/◀▶** and press **ENTER**
4. Press **▲▼/◀▶** to select "**Option**" - "**Option for view**", and press **ENTER**
5. Select "**Wide mode**", and then press **ENTER**
6. Select the desired screen size from the screen size selection menu
 - When you need to adjust the screen, refer to the following.

Adjusting the screen of PC connected to INPUT1 to 4

- Press **MENU** to display the Menu, press **▲▼/◀▶** and **ENTER** to select "**Setup**" - "**Option**" - "**Screen effect**" - "**Position**" to configure the settings. (page [3-41](#))

Contents

1. Part Names
2. Basic Operation
3. Menu Operation
4. USB Media
5. AQUOS LINK and Other Devices
6. Operating the Monitor Using a PC (IP control)
7. Troubleshooting
8. Specifications, etc.

You can select an OSD language from among 7 languages.

English >>

Deutsch >>

Français >>

Italiano >>

Español >>

Русский >>

Polski >>

Ver. 1.15

AQUOS LINK and Other Devices

Connecting PC

When the monitor is connected to a PC with DVI output terminal (digital connection)

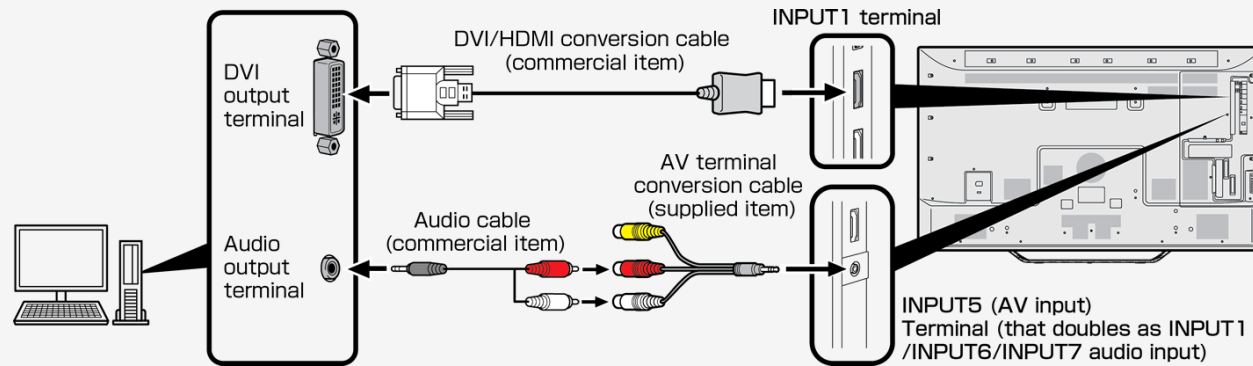

- Be sure to use the supplied conversion cable. When using any conversion cable other than the supplied one, the Monitor may not operate properly, or breakages may occur.
- A commercially available DVI / HDMI conversion cable and an audio cable are required.
- Use an audio cable that is compatible with the terminal of PC.
- The HDMI terminal of the Monitor, and the PC DVI terminal with a conversion cable, the PC screen may not be displayed properly or completely. This is because the cable does not sufficiently meet HDMI standards.
- "This input signal is not supported" message will be displayed when an unsupported signal is input. In such situation, refer to the operation manual of the connected PC and change to the supported signal.
- After switching to INPUT 1, select **"Setup"** - **"(Option)"** - **"Terminal setting"** - **"INPUT1 audio select"** from the Menu, and then select **"Analogue audio input"**.

Contents

1. Part Names
2. Basic Operation
3. Menu Operation
4. USB Media
5. AQUOS LINK and Other Devices
6. Operating the Monitor Using a PC (IP control)
7. Troubleshooting
8. Specifications, etc.

You can select an OSD language from among 7 languages.

English >>

Deutsch >>

Français >>

Italiano >>

Español >>

Русский >>

Polski >>

Ver. 1.15

AQUOS LINK and Other Devices

Connecting PC

When the monitor is connected to a PC with HDMI output terminal (digital connection)

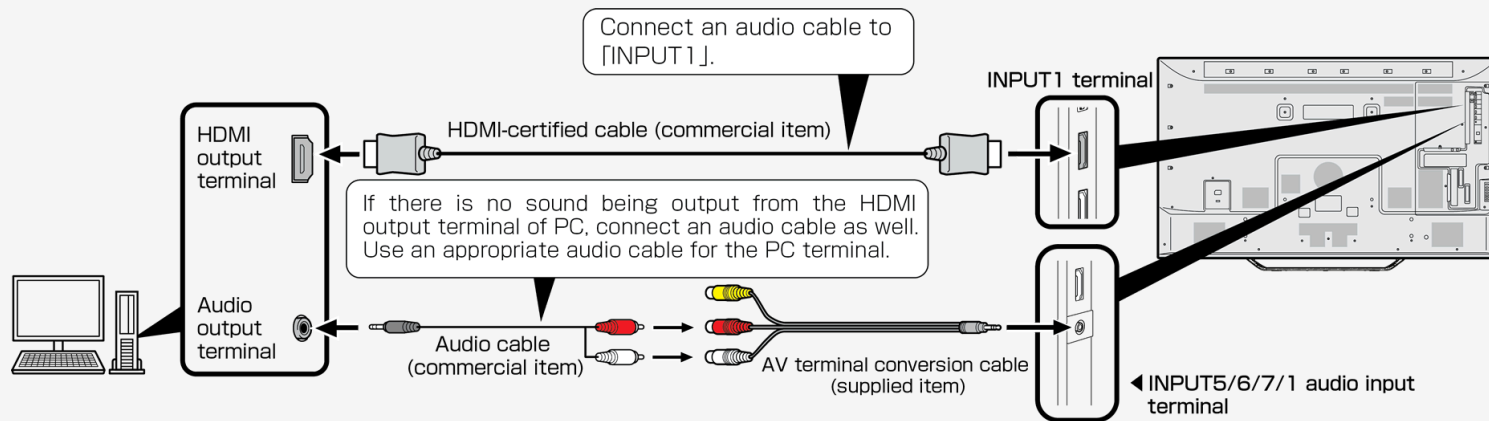

- Be sure to use the supplied conversion cable. When using any conversion cable other than the supplied one, the Monitor may not operate properly, or a part may be broken.
- A commercially available HDMI-certified cable is required.
- After switching to INPUT 1, select "**Setup**" - "**Option**" - "**Terminal setting**" - "**INPUT1 audio select**" from the Menu, and then select "**Analogue audio input**".

Contents

1. Part Names
2. Basic Operation
3. Menu Operation
4. USB Media
5. AQUOS LINK and Other Devices
6. Operating the Monitor Using a PC (IP control)
7. Troubleshooting
8. Specifications, etc.

You can select an OSD language from among 7 languages.

English >>

Deutsch >>

Français >>

Italiano >>

Español >>

Русский >>

Polski >>

Ver. 1.15

AQUOS LINK and Other Devices

Connecting PC

When the monitor is connected to a PC with analog RGB output terminal (digital connection)

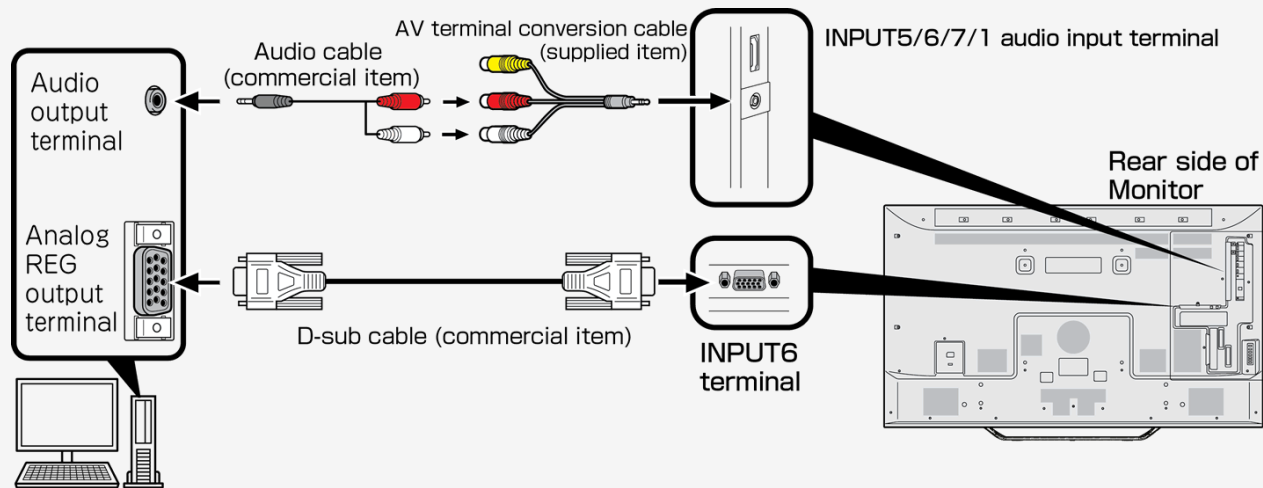

- Be sure to use the supplied conversion cable. When using any conversion cable other than the supplied one, the Monitor may not operate properly, or a part may be broken.
- A commercially available D-sub cable and an audio cable are required.
- Use an audio cable that is compatible with the PC terminal.
- After switching to INPUT 6, select "**Setup**" - "**Option**" - "**Terminal setting**" - "**INPUT6 audio select**" from the Menu, and then select "**Analogue audio input**".

Contents

1. Part Names
2. Basic Operation
3. Menu Operation
4. USB Media
5. AQUOS LINK and Other Devices
6. Operating the Monitor Using a PC (IP control)
7. Troubleshooting
8. Specifications, etc.

You can select an OSD language from among 7 languages.

English >>

Deutsch >>

Français >>

Italiano >>

Español >>

Русский >>

Polski >>

Ver. 1.15

Operating the Monitor Using a PC (IP control)

Connecting the Monitor and PC

- The Monitor is connected using a commercially available LAN cable.

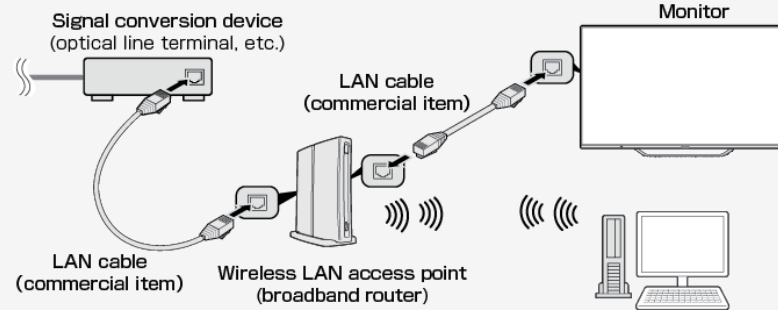

How to communicate

- Send a control command from PC. The Monitor operates according to the transmitted command, and sends a response message back to PC.
- Do not send more than one command at the same time. Send next command from PC after it receives the successful return value (OK).

Command (PC to Monitor)

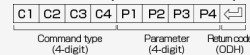

Response (Monitor to PC)

When successful When unsuccessful (in the event of a communication or command error)



Contents

1. Part Names
2. Basic Operation
3. Menu Operation
4. USB Media
5. AQUOS LINK and Other Devices
6. Operating the Monitor Using a PC (IP control)
7. Troubleshooting
8. Specifications, etc.

You can select an OSD language from among 7 languages.

English >>

Deutsch >>

Français >>

Italiano >>

Español >>

Русский >>

Polski >>

Ver. 1.15

Operating the Monitor Using a PC (IP control)

Connecting the Monitor and PC

Command and argument

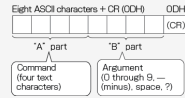

- In the "B" part field, characters should be entered left-aligned, and fill the rest of the field length with spaces. (Must be 4 characters.) If it is outside the settable range, "ERR" is returned.

	Argument examples
Enter 0	0 0000
Enter -30	- 30 0000
Enter 100	1 0 0 0000
Enter 55	0 0 5 5

- Any argument shown as "-" in the command list on page 6-4 to 6-6 can take on any one of the followings:"0" to "9", "-" (minus), space or "?"
- Certain commands return the currently set value whenever "?" is assigned to their arguments.

Argument examples			
?	0000	0000	0000
?	?	?	?

Contents

1. Part Names
2. Basic Operation
3. Menu Operation
4. USB Media
5. AQUOS LINK and Other Devices
6. Operating the Monitor Using a PC (IP control)
7. Troubleshooting
8. Specifications, etc.

You can select an OSD language from among 7 languages.

English >>
Deutsch >>
Français >>
Italiano >>
Español >>
Русский >>
Polski >>

Ver. 1.15

Operating the Monitor Using a PC (IP control)

Settings to operate the Monitor

How to communicate

- This is required to operate the Monitor remotely using a mobile device or PC.
- Using a terminal emulator, you can perform the Monitor operations, such as channel change, volume control and input change.
- This should be used by those who are computer-literate.
- For information on connecting to PC, see page [6-1](#).

1. Display the Menu, and select "**Setup**" - "**Initial setup**" - "**Network setup**"
2. Select "**IP control setup**"
3. Select "**IP control setup**"
4. Press "**Change**" to confirm
5. Follow on-screen instructions to establish the standby mode.
 - To turn on or off the Monitor using a mobile device or PC while it is in standby mode, you need to set the standby mode to "**Yes (Always)**".
6. Select "**Detail setting**" and press "**OK**".
7. Follow the on-screen instruction to configure "**Login Info**" settings.
 - Configuration of the login information (Login ID and Password) settings can prevent the Monitor from being operated by unauthorized devices.
8. Follow the on-screen instructions to configure the "**Control port**" setting.
 - This is required for terminal emulators on PC.
 - Any settable value cannot be set to the port (22).
9. Select "**Complete**" and press "**OK**".



Contents

1. Part Names
2. Basic Operation
3. Menu Operation
4. USB Media
5. AQUOS LINK and Other Devices
6. Operating the Monitor Using a PC (IP control)
7. Troubleshooting
8. Specifications, etc.

You can select an OSD language from among 7 languages.

English >>

Deutsch >>

Français >>

Italiano >>

Español >>

Русский >>

Polski >>

Ver. 1.15



Operating the Monitor Using a PC (IP control)

Command list

- Any commands not listed in the following table are out of operation guarantee range.

Function		"A"part	"B"part	Part operation description	Remarks
Power		POWR	0	Power off	Transition to standby
		POWR	1	Power on	Return from standby
Input change	Toggle	ITGD	0	(Toggle)	
	INPUT 1 to 4 (HDMI)	IAVD	1 to 4	(Input terminal number)	Change to INPUT 1 to INPUT 4
	INPUT 5 (video)	IAVD	5		Change to INPUT 5
	INPUT 6 (analog RGB)	IAVD	6		Change to INPUT 6
	INPUT 7 (8K: HDMI×4)	IAVD	7		Change to INPUT 7
AV MODE		AVMD	0	(Toggle)	Toggled among currently selectable items
			1	STANDARD	
			2	MOVIE	
			3	USER	
			7	PC	
			507	MOVIE(HDR)	
			11	PHOTO	
			6	DYNAMIC	
	5	DYNAMIC(Fixed)			

Contents

1. Part Names
2. Basic Operation
3. Menu Operation
4. USB Media
5. AQUOS LINK and Other Devices
6. Operating the Monitor Using a PC (IP control)
7. Troubleshooting
8. Specifications, etc.

You can select an OSD language from among 7 languages.

English >>

Deutsch >>

Français >>

Italiano >>

Español >>

Русский >>

Polski >>

Ver. 1.15

Operating the Monitor Using a PC (IP control)

Command list

Function		"A" part	"B" part	Part operation description	Remarks
Picture	Backlight	VLMP	-16 to 16	Backlight setup	
	Contrast	CONT	0 to 40	Contrast setup	
	Brightness	BLVL	-30 to 30	Brightness setup	
	Colour	COLR	-30 to 30	Colour setup	
	Tint	TINT	-30 to 30	Tint setup	
	Sharpness	SHRP	0 to 20	Sharpness setup	
Volume		VOLM	0 to 100	Volume value	
Balance		SBAL	-30 to 30	Speaker output balance setup	
Screen	Horizontal position	HPOS	*	Moving value	PC input (°)
	Vertical position	VPOS	*	Moving value	PC input (°)
	Clock frequency	CLCK	*	Moving value	PC input (°)
	Clock phase	PHSE	*	Moving value	PC input (°)

Contents

1. Part Names
2. Basic Operation
3. Menu Operation
4. USB Media
5. AQUOS LINK and Other Devices
6. Operating the Monitor Using a PC (IP control)
7. Troubleshooting
8. Specifications, etc.

You can select an OSD language from among 7 languages.

English >>

Deutsch >>

Français >>

Italiano >>

Español >>

Русский >>

Polski >>

Ver. 1.15

Operating the Monitor Using a PC (IP control)

Command list

Function	"A"part	"B"part	Part operation description	Remarks
Screen size	WIDE	0	(Toggle)	Toggles among currently selectable items
		1	Normal	
		2	Smart zoom	
		3	Wide 4:3	
		4	Zoom	
		5	Full	
		6	Full 1	
		7	Full 2	
		8	Underscan	
		9	Dot by Dot	
		10	Wide 16:9	
Mute	MUTE	0	(Toggle)	Toggles between mute states
		1	Mute	
		2	Unmute	
Surround	ACSU	0	(Toggle)	Toggles among mute states
		1	On	
		2	Off	
		3	Auto	

*The range varies depending on input, signal or screen size.

NOTE

- For "-" in the "B"part, any of the followings can be entered: "0" to "9", "-" (minus), space or "?".
- The selectable screen size varies depending on the input signal.

Contents

1. Part Names
2. Basic Operation
3. Menu Operation
4. USB Media
5. AQUOS LINK and Other Devices
6. Operating the Monitor Using a PC (IP control)
7. Troubleshooting
8. Specifications, etc.

You can select an OSD language from among 7 languages.

- English >>
- Deutsch >>
- Français >>
- Italiano >>
- Español >>
- Русский >>
- Polski >>

Ver. 1.15



Troubleshooting

If You Suspect a Problem

If you encounter a problem, verify the problem before asking for repair.

Check the following;

The power cannot be turned on

Be sure to insert the power cord plug all the way in.

(The operation manual supplied with the Monitor "Connecting AC Cord")

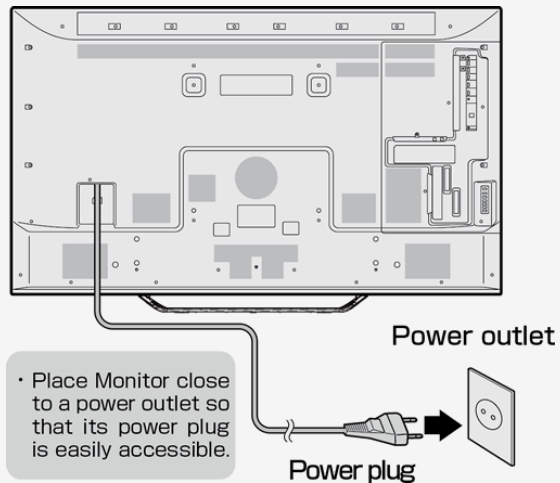

Contents

1. Part Names
2. Basic Operation
3. Menu Operation
4. USB Media
5. AQUOS LINK and Other Devices
6. Operating the Monitor Using a PC (IP control)
7. Troubleshooting
8. Specifications, etc.

You can select an OSD language from among 7 languages.

English >>

Deutsch >>

Français >>

Italiano >>

Español >>

Русский >>

Polski >>

Ver. 1.15



Troubleshooting

If You Suspect a Problem

Check the following;

The power cannot be turned on (Continue)

If the lamp is not lit, press the power button on the Monitor to turn on the power.

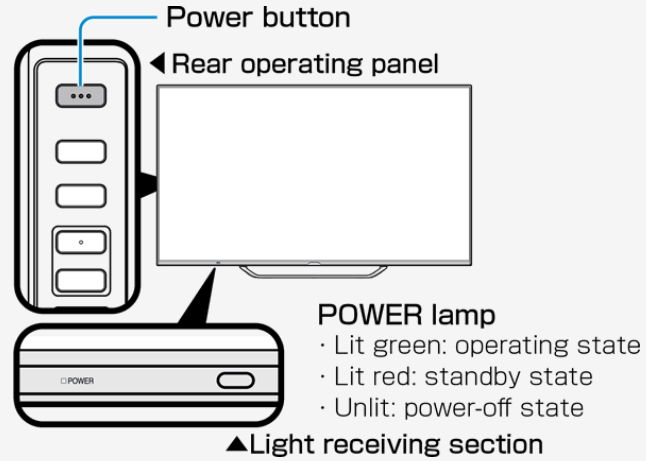

- The POWER lamp stays lit even after the Monitor is turned off by pressing its power button. It can be turned on with the remote control.
- To turn off the POWER lamp and prevent it from being turned on with the remote control, change "**Power button setting**" to "**Mode2**". (page [3-4](#))

Contents

1. Part Names
2. Basic Operation
3. Menu Operation
4. USB Media
5. AQUOS LINK and Other Devices
6. Operating the Monitor Using a PC (IP control)
7. Troubleshooting
8. Specifications, etc.

You can select an OSD language from among 7 languages.

English >>

Deutsch >>

Français >>

Italiano >>

Español >>

Русский >>

Polski >>

Ver. 1.15



Troubleshooting

If You Suspect a Problem

General

What if	Where to check	Reference page
There is no video and sound output from the Monitor	Is the power plug unplugged from the outlet?	The operation manual supplied with the Monitor "Connecting AC Cord"
	Is the POWER lamp lit green?	2-1
	Is the input changed to a proper source to permit a video from an external device to be played on the Monitor?	5-20 to 5-21
	Is any connecting cable disconnected?	—
The remote control does not operate	Is the POWER lamp lit green?	2-3
	Isn't the polarity (+, -) of the dry battery reversed?	The operation manual supplied with the Monitor "Preparation and How to Use Remote Control Unit"
	Are the dry batteries for the remote control drained? The higher the use frequency is, the faster the dry batteries may be drained. Whenever there is a sign of draining of a dry battery, such as when the Monitor does not respond to the remote control, replace the dry battery with a new one early.	The operation manual supplied with the Monitor "Preparation and How to Use Remote Control Unit"
	Do you point the remote control toward the light receiving section of the Monitor when using it?	The operation manual supplied with the Monitor "Preparation and How to Use Remote Control Unit"
	You will have difficulty operating the remote control if any of the following apply: <ul style="list-style-type: none"> • There is an obstacle between the remote control and the remote control light receiving section of the Monitor. • The remote control light receiving section is exposed to direct sunlight or intensified light. • Try to angle the light. • There is a light source, such as a fluorescent, near the Monitor. • A battery terminal is oxidized (darkened)? • The room temperature is extremely low. 	—

Contents

1. Part Names
2. Basic Operation
3. Menu Operation
4. USB Media
5. AQUOS LINK and Other Devices
6. Operating the Monitor Using a PC (IP control)
7. Troubleshooting
8. Specifications, etc.

You can select an OSD language from among 7 languages.

English >>

Deutsch >>

Français >>

Italiano >>

Español >>

Русский >>



Polski >>

Ver. 1.15

Troubleshooting

If You Suspect a Problem

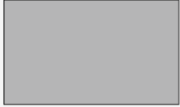
General

What if	Where to check	Reference page
 Video appears on Monitor but no sound comes out of it	Is the volume control set to the minimum level?	2-3
	Is it set to "Mute"?	—
	Is the headphone left plugged into the headphone terminal?	1-2
The audio sound differs in volume level from one input source to another	Because the input sound level may vary depending on the device connected or the disk played back, the volume can be set per input. Set the volume control for each input.	2-3
	Is the external device unplugged?	—
	Is the external device turned on?	—
	Have you selected the input to which the external device is connected?	5-20 to 5-21
Video image from a BD player or external device does not appear, or stopped appearing, on the Monitor	For INPUT 5 or INPUT 6, due to the provisions of Advanced Access Content System (AACS), BD videos (commercial blue-ray software) from certain external devices connected to the INPUT cannot be played back on the Monitor.	—
	Due to copyright restrictions, videos from certain devices fail to appear on Monitor unless the devices are directly connected to the Monitor through HDMI cable.	—
	Is Audio Only set to "On"?	3-32
 Sound comes out of the Monitor but no video appears on it	Is the video cable disconnected?	5-16
	 Faded poorly tinted	Are " Colour " and " Tint " for video picture properly adjusted?
Due to the viewing angle characteristics of the LC panel, when viewed from an oblique direction, some video pictures may look faded or have a different color tone. This is not a failure.		—

Contents

1. Part Names
2. Basic Operation
3. Menu Operation
4. USB Media
5. AQUOS LINK and Other Devices
6. Operating the Monitor Using a PC (IP control)
7. Troubleshooting
8. Specifications, etc.

You can select an OSD language from among 7 languages.

English >>

Deutsch >>

Français >>

Italiano >>

Español >>

Русский >>

Polski >>

Ver. 1.15



Troubleshooting

If You Suspect a Problem

General

What if	Where to check	Reference page
The screen is dim	Is there any object placed in front of the brightness sensor?	1-1
	Change " Picture ".	3-8 to 3-17
	Adjust " Backlight ".	3-9
	Check " AV Mode ".	3-8
Underexposure	Adjust " Backlight ", " Brightness ", or " Advanced " - " Gamma adjustment ".	3-9 to 3-15
The display screen increases or decreases in size	Is the Auto Wide function set to " On "? Change the setting to " Off ".	3-42
The screen flickers or has poor resolution or noise	Set " DNR " for " Advanced " to " Auto ", " High ", " Middle " or " Low ".	3-16
The monitor gets warm/hot at the top	This is because the Monitor is structured to allow the air heated with the heat from internal circuits to naturally flow out through its top. When the Monitor increases abnormally in temperature, the letters " Temperature " or " Temperature of monitor " blink at the bottom right corner of the screen, causing it to automatically turn off afterwards.	—
	This is due to an increase in the temperature of the Monitor. Eliminate the cause of the temperature increase.	—
	Check the installation condition or location of the Monitor for potential causes of temperature increase. Install the Monitor so that ventilation holes in its rear are not blocked.	—
The letters " Temperature " or " Temperature of monitor " blink at the bottom right corner of the screen. Subsequent to that, the Monitor turns off automatically.	Frequently eliminate any dust settling inside the Monitor or ventilation holes if it is possible to dust from the outside of Monitor.	—

Contents

1. Part Names
2. Basic Operation
3. Menu Operation
4. USB Media
5. AQUOS LINK and Other Devices
6. Operating the Monitor Using a PC (IP control)
7. Troubleshooting
8. Specifications, etc.

You can select an OSD language from among 7 languages.

English >>

Deutsch >>

Français >>

Italiano >>

Español >>

Русский >>

Polski >>

Ver. 1.15



Troubleshooting

If You Suspect a Problem

General

What if	Where to check	Reference page
You cannot operate the buttons on the remote control or Monitor	It may be attributable to external or interference noises. Set the "Power button setting" to "Mode2" , turn off the Monitor with its power button, leave it alone for about a minute after unplugging the power plug, and then plug the power plug back in again to turn its power on.	3-4
	Isn't the RC control lock set to On? If it has been set to On by mistake, in the Setup menu, select "  (Ecology)" - "Child Lock" , and then set it to "Off" . (When using buttons on the Monitor, see page 1-6 .)	—
	You can also check video for child lock.	—
You hear a crack sometimes	It is a sound of the cabinet slightly expanding or contracting with changes in temperature. It has no impact on performance, etc.	—

Contents

1. Part Names
2. Basic Operation
3. Menu Operation
4. USB Media
5. AQUOS LINK and Other Devices
6. Operating the Monitor Using a PC (IP control)
7. Troubleshooting
8. Specifications, etc.

You can select an OSD language from among 7 languages.

English >>

Deutsch >>

Français >>

Italiano >>

Español >>

Русский >>

Polski >>

Ver. 1.15



Troubleshooting

If You Suspect a Problem

General

What if	Where to check	Reference page
Input change does not allow selection	Is the input skip set to " No "?	5-23
The power turns off automatically	Check if the Monitor is in the mode where it is turned off automatically.	—
The POWER lamp does not go off at the press of the power button on the Monitor	If the power button setting is set to " Mode1 ", the power turns off at the press of the power button on the Monitor, but the POWER lamp stays lit. The lamp is lit red (standby).	3-4

8K input

What if	Where to check	Reference page
Not shown as 4320p	Check if four HDMI cables are inserted into A to D of INPUT 7. Check the resolution of the output device.	5-1 to 5-3
No video appears	Any connections to HDMI 1 to 4?	5-1 to 5-2
No sound is coming out	Go to " INPUT7 audio select " where you should select the audio input terminal used. The compatible format is Linear PCM only.	5-4

If any problem persists after you try the corresponding solution above, be sure to unplug the power plug and then contact your local distributor.

Contents

1. Part Names
2. Basic Operation
3. Menu Operation
4. USB Media
5. AQUOS LINK and Other Devices
6. Operating the Monitor Using a PC (IP control)
7. Troubleshooting
8. Specifications, etc.

You can select an OSD language from among 7 languages.

English >>

Deutsch >>

Français >>

Italiano >>

Español >>

Русский >>

Polski >>

Ver. 1.15



Troubleshooting

If You Suspect a Problem

IP control-related

What if	Where to check	Reference page
No IP control	Go to the setup menu, and then "  (Initial Setup)" - "Network Setup" - "IP Control setup". Check if it is set to "Enable".	3-3

AQUOS LINK-related

What if	Where to check	Reference page
AQUOS LINK does not operate properly	Check " Select AQUOS Link device ", and select a device used for recording and AQUOS LINK.	5-11
	The AQUOS LINK operates with the INPUT 1 through 4. It does not operate with INPUT 7.	5-1

Contents

1. Part Names
2. Basic Operation
3. Menu Operation
4. USB Media
5. AQUOS LINK and Other Devices
6. Operating the Monitor Using a PC (IP control)
7. Troubleshooting
8. Specifications, etc.

You can select an OSD language from among 7 languages.

English >>

Deutsch >>

Français >>

Italiano >>

Español >>

Русский >>

Polski >>

Ver. 1.15



Troubleshooting

If Error Message Appears

Message concerning USB Media

On-screen error message example	Solution
The power supply requirement of the connected USB device is too large. After turning power off the Monitor, connect only necessary USB devices.	USB inrush current has occurred. It can occur when multiple USB devices are connected to the Monitor. Turn off the Monitor, and then disconnect any unnecessary USB devices.
Cannot display the data.	Data in any format other than JPEG, which is compatible with the Monitor, or corrupted data cannot be displayed.

Contents

1. Part Names
2. Basic Operation
3. Menu Operation
4. USB Media
5. AQUOS LINK and Other Devices
6. Operating the Monitor Using a PC (IP control)
7. Troubleshooting
8. Specifications, etc.

You can select an OSD language from among 7 languages.

English >>

Deutsch >>

Français >>

Italiano >>

Español >>

Русский >>

Polski >>

Ver. 1.15



Troubleshooting

If Error Message Appears

Message concerning USB Media

On-screen error message example	Solution
Cannot play. Unable to play this file.	Out-of-spec video data cannot be played back. Check if the video data format can be played back on the Monitor. "About files in USB memory that can be played on Monitor" (see page 4-4)
Cannot play. Cannot playback the audio file.	Out-of-spec music data cannot be played back. Check if the music data format can be played back on the Monitor. "About files in USB memory that can be played on Monitor" (see page 4-4)

Contents

1. Part Names
2. Basic Operation
3. Menu Operation
4. USB Media
5. AQUOS LINK and Other Devices
6. Operating the Monitor Using a PC (IP control)
7. Troubleshooting
8. Specifications, etc.

You can select an OSD language from among 7 languages.

- English >>
- Deutsch >>
- Français >>
- Italiano >>
- Español >>
- Русский >>
- Polski >>

Ver. 1.15

Troubleshooting

What If

If the Monitor cannot be operated

- If the Monitor is exposed to intensive external noise (very large amount of static electricity, source voltage error caused by lighting strike, etc.), or if you operate the Monitor in an improper manner, an error may result, such as failure to operate or control the Monitor.
- In such a case, press the power button on the Monitor to temporarily turn the power off, and then turn the power back on to retry an operation that previously failed.
- If you still fail to operate the Monitor even after turning the power on again, keep pressing the power button on the Monitor for at least five seconds. That turns off the Monitor. Wait about a minute before pressing the power button to turn the Monitor back on, and then retry the operation again. Even after these button operations above, setting items such as menu.

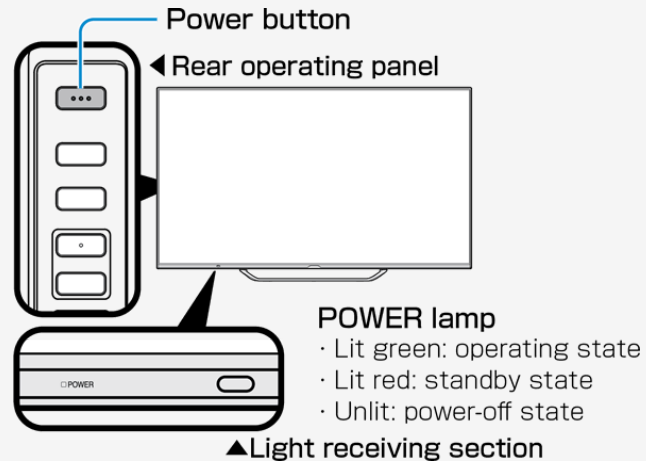

NOTE

- Since data is loaded into the Monitor immediately after it is turned back on, it takes some time before a screen is displayed.

Contents

1. Part Names
2. Basic Operation
3. Menu Operation
4. USB Media
5. AQUOS LINK and Other Devices
6. Operating the Monitor Using a PC (IP control)
7. Troubleshooting
8. Specifications, etc.

You can select an OSD language from among 7 languages.

English >>

Deutsch >>

Français >>

Italiano >>

Español >>

Русский >>

Polski >>

Ver. 1.15

Specifications, etc.

Specifications

Product name		LCD monitor		
Model name		LV-70X500E	Speaker	Full range x 2 pcs, subwoofer x 1 pc
LCD panel	Display size	70" class (153.9cm wide x 86.6cm long/176.6cm diagonal)		Annual power consumption
	Drive system	TFT (thin-film transistor) active-matrix drive system		
	Pixel count	7,680 (horizontal) x 4,320 (vertical) pixels		On mode power: 260W Annual power consumption: 361kWh/year
	Light source used	LED		Operating temperature
Maximum effective output power		35W (10W+10W+15W)		Applied power supply
Power consumption		445W (during standby: 0.5W)		
Connection terminal		HDMI input terminals (INPUT 1: HDR (PQ/HLG) compatible, INPUT 2: ARC-compatible) x 4, 8K video-compatible terminal (INPUT 7: HDR (PQ/HLG) compatible) x 1 AV input (doubles as INPUT 1/6/7 audio input) terminal x 1, analog audio output terminal x 1, digital audio output (optical) terminal x 1, headphone connection terminal x 1, USB terminals x 2, LAN terminal (10BASE-T/100BASE-TX) x 1, analog RGB (PC input) terminal x 1		
External dimension W x D x H (mm)		The display only: 1564 x 92 x 910 With the stand: 1564 x 375 x 967		
Mass		The display only: approx. 42.5kg With the stand: approx. 45.0kg		

As part of policy of continuous improvement, SHARP reserves the right to make design and specification changes for product improvement without prior notice. The performance specification figures indicated are nominal values of production units. There may be some deviations from these values in individual units.

Contents

1. Part Names
2. Basic Operation
3. Menu Operation
4. USB Media
5. AQUOS LINK and Other Devices
6. Operating the Monitor Using a PC (IP control)
7. Troubleshooting
8. Specifications, etc.

You can select an OSD language from among 7 languages.

English >>
Deutsch >>
Français >>
Italiano >>
Español >>
Русский >>
Polski >>

Ver. 1.15

Specifications, etc.

PC Supported signal timing

Screen resolution		Horizontal frequency (kHz)	Vertical frequency (Hz)	Digital (HDMI)	Analog (D-SUB)
VESA	640 x 480	31.5	60	o	o
		37.9	72	o	o
		37.5	75	o	o
	800 x 600	35.1	56	o	o
		37.9	60	o	o
		48.1	72	o	o
		46.9	75	o	o
	1024 x 768	48.4	60	o	o
		56.5	70	o	o
		60.0	75	o	o
		49.7	60	o	o
	1280 x 800	49.7	60	o	o
	1366 x 768	47.7	60	o	o
1280 x 1024	64.0	60	o	o	
1400 x 1050	65.3	60	o	o	
	720 x 400	31.5	70	o	o
	720 x 480	31.5	60	o	o
	1920 x 1080	33.8	60	o	—
	1280 x 720	45.0	60	o	o
	1920 x 1080	67.5	60	o	o
	3840 x 2160	53.95	24	o	—
		56.3	25	o	—
		67.5	30	o	—
		112.5	50	o	—
		135.0	60	o	—

- Depending on the PC connected, even the supported signals above may not be transmitted or displayed properly.
- For 8K input, see page [7-7](#).

Contents

1. Part Names
2. Basic Operation
3. Menu Operation
4. USB Media
5. AQUOS LINK and Other Devices
6. Operating the Monitor Using a PC (IP control)
7. Troubleshooting
8. Specifications, etc.

You can select an OSD language from among 7 languages.

English >>

Deutsch >>

Français >>

Italiano >>

Español >>

Русский >>

Polski >>

Ver. 1.15

Specifications, etc.

AV Supported signal timing

Resolution	Vertical frequency (Hz)	Digital (HDMI)	Analog (D-SUB)
1920 x 1080p	24	o	—
	29.98	o	—
	30	o	—
	50	o	—
	59.94	o	o
1920 x 1080i	60	o	o
	59.94	o	—
	50	o	—
1280 x 720p	60	o	—
	29.98	o	—
	30	o	—
	50	o	—
	59.94	o	o
720 x 480p	60	o	o
	59.94	o	—
720 (1440) x 480i	60	o	—
	59.94	o	—
720 x 576p	50	o	—
720 (1440) x 576i	50	o	—

DDC (Plug & Play)

- The Monitor supports VESA Display Data Channel (DDC) Standard.
- DDC is a signal standard for Plug and Play between display and PC.
- Information such as the one about resolution, etc. is transmitted between the display and the PC.
- This feature is enabled when PC is DDC-compatible and set to detect a Plug and Play monitor.
- There are different types of DDC, depending on the communication system.
- The Monitor is DDC2B-compliant.

Contents

1. Part Names
2. Basic Operation
3. Menu Operation
4. USB Media
5. AQUOS LINK and Other Devices
6. Operating the Monitor Using a PC (IP control)
7. Troubleshooting
8. Specifications, etc.

You can select an OSD language from among 7 languages.

English >>

Deutsch >>

Français >>

Italiano >>

Español >>

Русский >>

Polski >>

Ver. 1.15



Specifications, etc.

PC/AV HDMI input terminal pin configuration

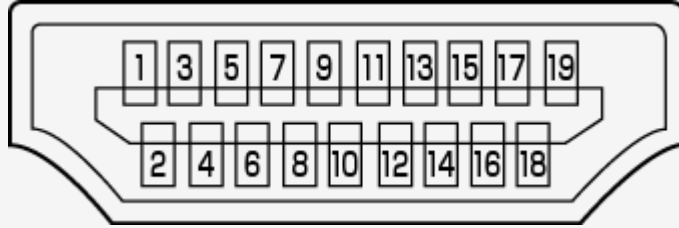

No.	Function	No.	Function
1	TMDS data 2+	11	TMDS clock shield
2	TMDS data 2 shield	12	TMDS clock -
3	TMDS data 2-	13	CEC
4	TMDS data 1+	14	N.C.
5	TMDS data 1 shield	15	SCL
6	TMDS data 1-	16	SDA
7	TMDS data 0+	17	DDC/CEC GND
8	TMDS data 0 shield	18	+5V
9	TMDS data 0-	19	Hot plug detection
10	TMDS clock +		

Contents

1. Part Names
2. Basic Operation
3. Menu Operation
4. USB Media
5. AQUOS LINK and Other Devices
6. Operating the Monitor Using a PC (IP control)
7. Troubleshooting
8. Specifications, etc.

You can select an OSD language from among 7 languages.

English >>

Deutsch >>

Français >>

Italiano >>

Español >>

Русский >>

Polski >>

Ver. 1.15



Specifications, etc.

PC/AV D-sub input terminal pin configuration

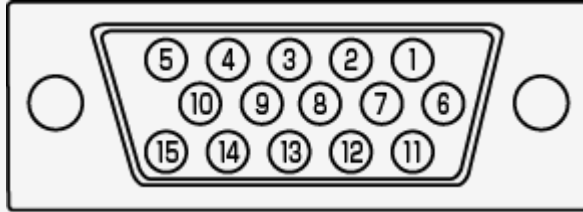

No.	Function	No.	Function
1	Red video signal input	9	+5V
2	Green video signal input	10	GND
3	Blue video signal input	11	N.C.
4	N.C.	12	DDC data
5	GND	13	Horizontal synchronization signal input
6	GND for red video signal	14	Vertical synchronization signal input
7	GND for green video signal	15	DDC clock
8	GND for blue video signal		

Contents

1. Part Names
2. Basic Operation
3. Menu Operation
4. USB Media
5. AQUOS LINK and Other Devices
6. Operating the Monitor Using a PC (IP control)
7. Troubleshooting
8. Specifications, etc.

You can select an OSD language from among 7 languages.

English >>

Deutsch >>

Français >>

Italiano >>

Español >>

Русский >>

Polski >>

Ver. 1.15



Specifications, etc.

Dimensional Drawing

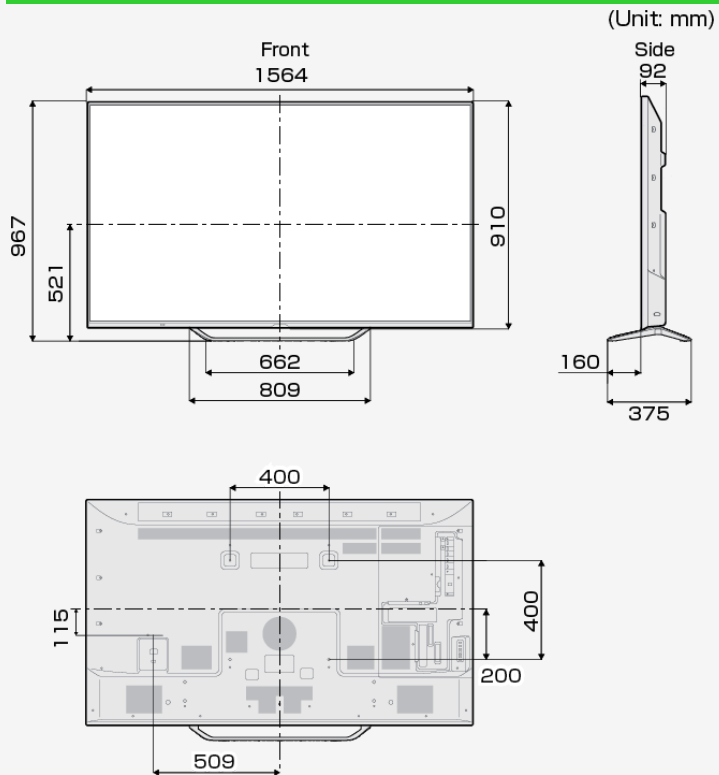

Contents

1. Part Names
2. Basic Operation
3. Menu Operation
4. USB Media
5. AQUOS LINK and Other Devices
6. Operating the Monitor Using a PC (IP control)
7. Troubleshooting
8. Specifications, etc.

You can select an OSD language from among 7 languages.

English >>

Deutsch >>

Français >>

Italiano >>

Español >>

Русский >>

Polski >>

Ver. 1.15

Specifications, etc.

Setting the Monitor on the Wall

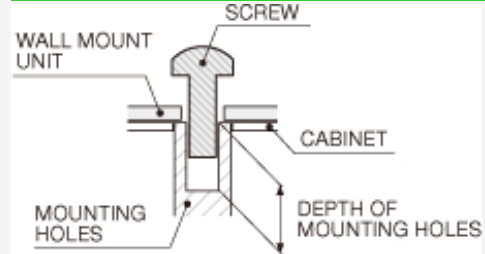

For the screws, refer to the table shown below.

Unit: mm

Standard screws	M6 (Use 1.0 pitch screws.)
Length(Depth of mounting holes)	12
Quantity	4 pcs.

NOTE

- To use this Monitor mounted on a wall, remove the cable tie as needed.
- Do not use screws that do not comply with the VESA standard screw specifications.
- Do not use screws that are longer than the standard length. Screws that are too long may cause damage to the inside of the Monitor.
- Do not fasten the screws too firmly or loosely. This may damage the product or cause the product to fall, leading to personal injury. SHARP is not liable for these kinds of accidents.
- SHARP is not liable for product damage or personal injury when a non-VESA or non-specified wall mount is used or the consumer fails to follow the product installation instructions.



Do not install the wall mount kit while your Monitor is turned on. It may result in personal injury due to electric shock.

Contents

1. Part Names
2. Basic Operation
3. Menu Operation
4. USB Media
5. AQUOS LINK and Other Devices
6. Operating the Monitor Using a PC (IP control)
7. Troubleshooting
8. Specifications, etc.

You can select an OSD language from among 7 languages.

English >>

Deutsch >>

Français >>

Italiano >>

Español >>

Русский >>

Polski >>

Ver. 1.15



Specifications, etc.

Software License

Information on the open-source software license.

Software composition

The software included in this product is comprised of various software components whose individual copyrights are held by third parties.

This product also makes use of freely distributed software and software components whose copyrights are held by third parties. These include software components covered by a GNU General Public License (hereafter GPL), a GNU Lesser General Public License (hereafter LGPL) or other license agreement.

Obtaining source code

Some of the open source software licensors require the distributor to provide the source code with the executable software components. GPL and LGPL include similar requirements. For information on obtaining the source code for the open source software and for obtaining the GPL, LGPL, and other license agreement information, visit the following website.

<http://www.sharp.co.jp/support/aquos/source/download/index.html>

We are unable to answer any questions about the source code for the open source software. The source code for the software components whose copyrights are held by SHARP is not distributed.

Contents

1. Part Names
2. Basic Operation
3. Menu Operation
4. USB Media
5. AQUOS LINK and Other Devices
6. Operating the Monitor Using a PC (IP control)
7. Troubleshooting
8. Specifications, etc.

You can select an OSD language from among 7 languages.

English >>

Deutsch >>

Français >>

Italiano >>

Español >>

Русский >>

Polski >>

Ver. 1.15



Specifications, etc.

Software License

Information on licenses of software used in the Monitor

NOTE

- Select "Setup" -  (Information) - "Software licence" on the MENU to display the information concerning the licenses of software used for the Monitor.

LCフォント、LCFONT、エルシーフォント and LC logo mark are registered trademarks of SHARP Corporation. This product is embedded with LC Font technology, which was developed by SHARP Corporation for clearly displaying easy-to-read characters on an LCD screen. However, other non-LCD fonts are used for displaying some screen pages.

Contents

1. Part Names
2. Basic Operation
3. Menu Operation
4. USB Media
5. AQUOS LINK and Other Devices
6. Operating the Monitor Using a PC (IP control)
7. Troubleshooting
8. Specifications, etc.

You can select an OSD language from among 7 languages.

English >>

Deutsch >>

Français >>

Italiano >>

Español >>

Русский >>

Polski >>

Ver. 1.15



Specifications, etc.

Software License

Trademark, Registered Trademark, etc.

- Manufactured under license from Dolby Laboratories. Dolby and the double-D symbol are trademarks of Dolby Laboratories.
- The terms HDMI and HDMI High-Definition Multimedia Interface, and the HDMI Logo are trademarks or registered trademarks of HDMI Licensing Administrator, Inc. in the United States and other countries.



<http://www.espial.com>

- THIS PRODUCT IS LICENSED UNDER THE AVC PATENT PORTFOLIO LICENSE FOR THE PERSONAL USE OF A CONSUMER OR OTHER USES IN WHICH IT DOES NOT RECEIVE REMUNERATION TO (i) ENCODE VIDEO IN COMPLIANCE WITH TROMHE AVC STANDARD ("AVC VIDEO") AND/OR (ii) DECODE AVC VIDEO THAT WAS ENCODED BY A CONSUMER ENGAGED IN A PERSONAL ACTIVITY AND/OR WAS OBTAINED F A VIDEO PROVIDER LICENSED TO PROVIDE AVC VIDEO. NO LICENSE IS GRANTED OR SHALL BE IMPLIED FOR ANY OTHER USE. ADDITIONAL INFORMATION MAY BE OBTAINED FROM MPEG LA, L.L.C. SEE <HTTP://WWW.MPEGLA.COM>
- THIS PRODUCT IS LICENSED UNDER THE MPEG-4 VISUAL PATENT PORTFOLIO LICENSE FOR THE PERSONAL AND NON-COMMERCIAL USE OF A CONSUMER FOR (i) ENCODING VIDEO IN COMPLIANCE WITH THE MPEG-4 VISUAL STANDARD ("MPEG-4 VIDEO") AND/OR (ii) DECODING MPEG-4 VIDEO THAT WAS ENCODED BY A CONSUMER ENGAGED IN A PERSONAL AND NON-COMMERCIAL ACTIVITY AND/OR WAS OBTAINED FROM A VIDEO PROVIDER LICENSED BY MPEG LA TO PROVIDE MPEG-4 VIDEO. NO LICENSE IS GRANTED OR SHALL BE IMPLIED FOR ANY OTHER USE. ADDITIONAL INFORMATION INCLUDING THAT RELATING TO PROMOTIONAL, INTERNAL AND COMMERCIAL USES AND LICENSING MAY BE OBTAINED FROM MPEG LA, L.L.C. SEE <HTTP://WWW.MPEGLA.COM>

Eilex's Audio Technology

- Manufactured under license from Eilex International, LLC
- Eilex PRISM is a trademark of Eilex International, LLC
- VIR Filter is a trademark of Eilex International, LLC
- Eilex PRISMTM equalizes acoustic power volume density frequency response and corrects time and phase alignment errors of a speaker system. Speakers with Eilex PRISM perform as near-perfect electro-acoustic transducers providing true-to-original sound with the highest musicality and intelligibility.
- VIR FilterTM is a high-performance filter developed for audio purposes.